

**NOTICE DE MONTAGE
ASSEMBLY INSTRUCTIONS
MONTAGEANLEITUNG
ISTRUZIONI DI MONTAGGIO
INSTRUÇÕES DE MONTAGEM
INSTRUCCIONES DE MONTAJE
UPUTE ZA MONTAZU
MONTAJ TALIMATI**

16315

16316

**BUFFET MISTI 2PCR2P2C
BUFFET MISTI 2GD2DO2D
BUFFET MISTI 2PV2P2T**

ME
marckeric

MARCKERIC S.L.
C/ ENLACE VEROLA S/N,
PC. 46430/SOLLANA / VALÈNCIA / SPAIN

EAN CODE: 8435178399243

8435178399250

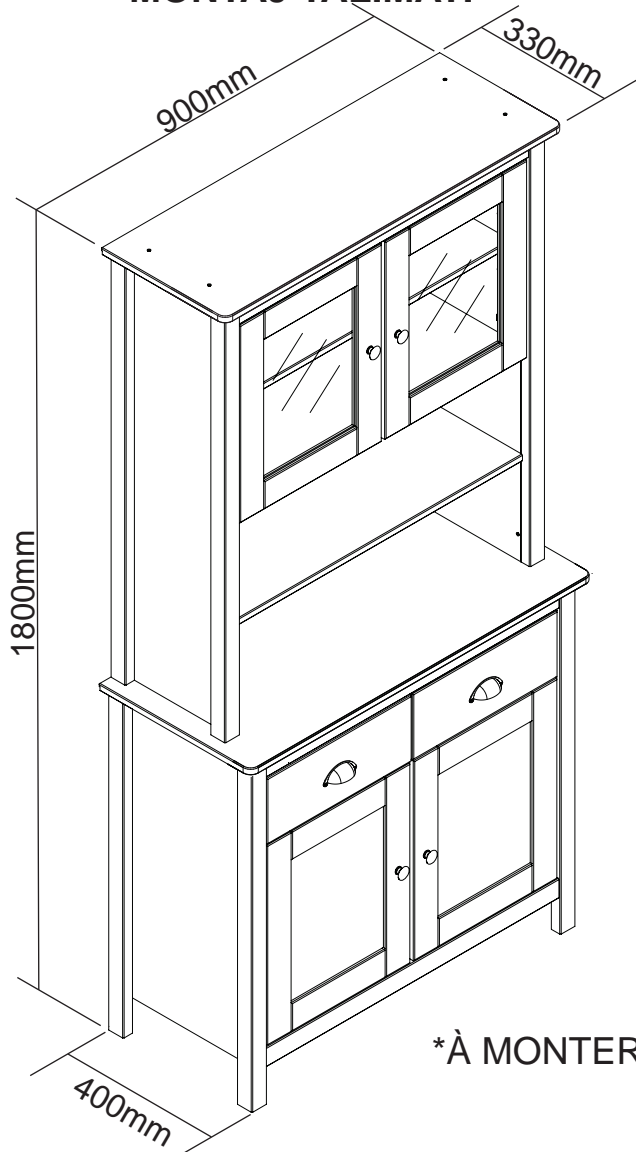

À MONTER SOI-MÊME

*AVANT DE COMMENCER, SE
REPORTER AUX CONSEILS
DE MONTAGE EN ANNEXE*

**BEFORE STARTING, REFER
TO THE ASSEMBLING ADVICE
IN ANNEX**

*VOR DER MONTAGE,
BEILIEGENDE ANWEISUNGEN
BEFOLGEN.*

*PRIMA DI COMINCIARE
LEGGETE LE ISTRUZIONI DI
MONTAGGIO*

*ANTES DE COMERÇAR, ADIAR
SE AOS CONSELHOS DE
MONTAGEM EM ANEXO*

**ANTES DE EMPEZAR
CONSULTE LOS CONSEJOS
PARA EL MONTAJE**

*PRIJE POÇETKA MONTAŽE
MOLIMO PAŽLJIVO
PROČITAJTE UPUTE ZA
MONTAŽU*

**BASLAMADAN ÖNCE,
EKTEKI MONTAJ TALIMATLARINI
İNCELEYİNİZ**

***IMPORTANT: À CONSERVER POUR RÉFÉRENCE ULTÉRIEURE - LIRE ATTENTIVEMENT*
NE PAS UTILISER SI UNE PARTIE EST CASSÉE, ENDOMMAGÉE OU MANQUANTE**

Caja Colis	Tamaño de la caja Dimensions colis	Peso bruto Poids brut	Peso neto Poids net
1/2	940 x 475 x 135 mm	21,50 Kg	20,50 Kg
2/2	1020 x 605 x 110 mm	21,40 Kg	20,40 Kg

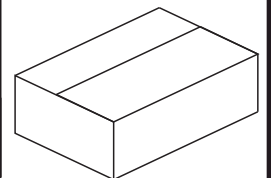

1PC / 2CTN

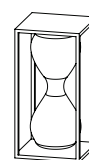
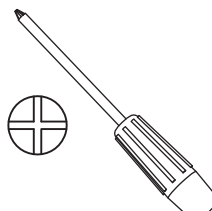
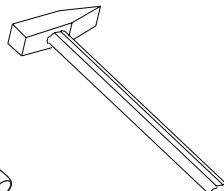
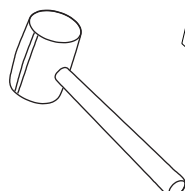
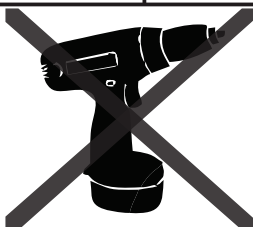

150min.

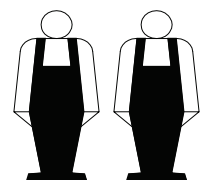

CAJA-COLIS 1/2

- COMPLETE INFERIOR BUFFET
- QUINCALLERIE
- NOTICE DE MONTAGE

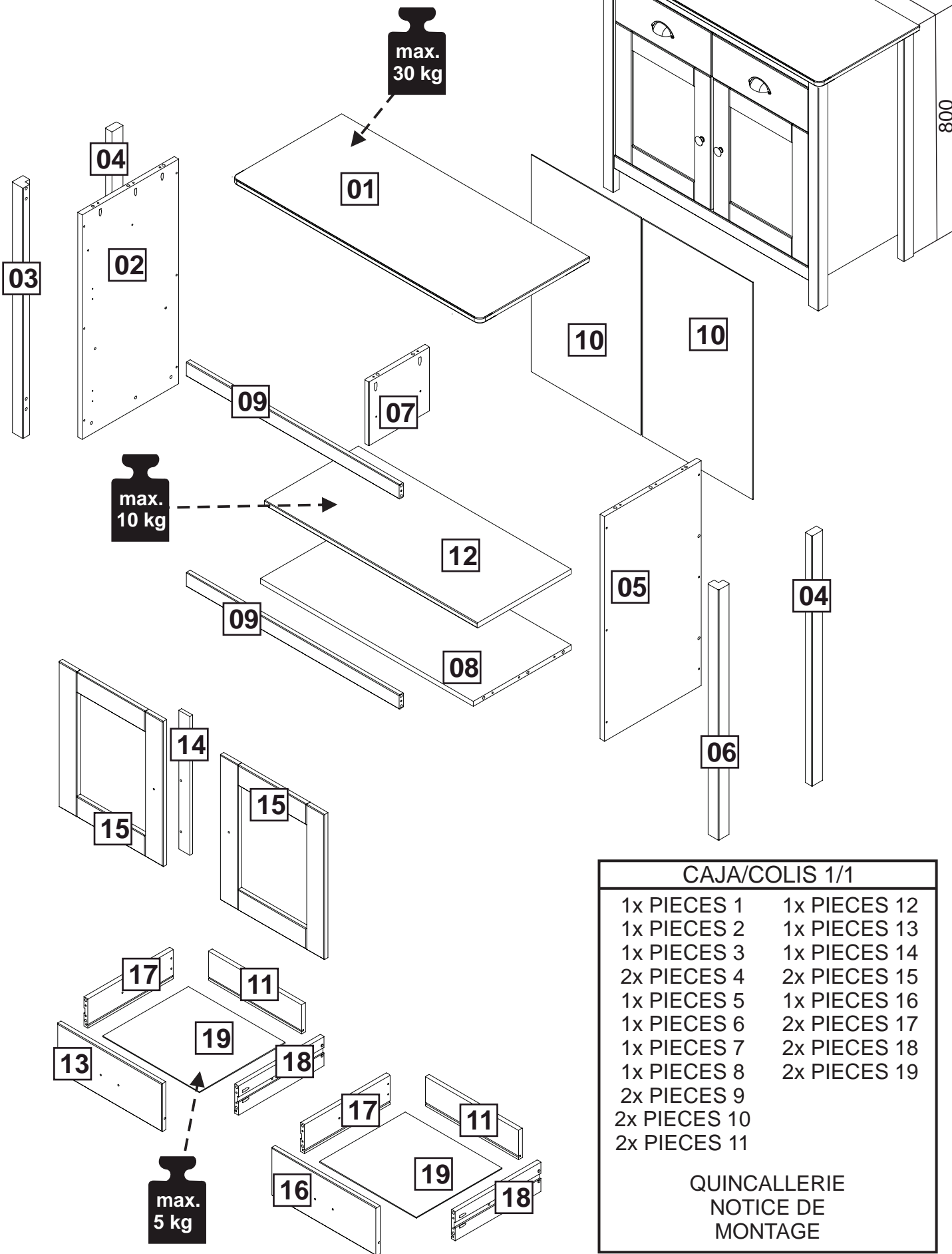
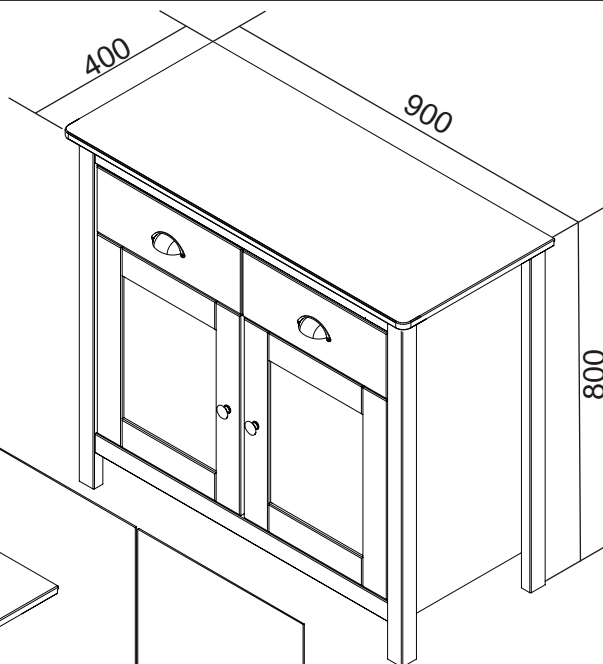



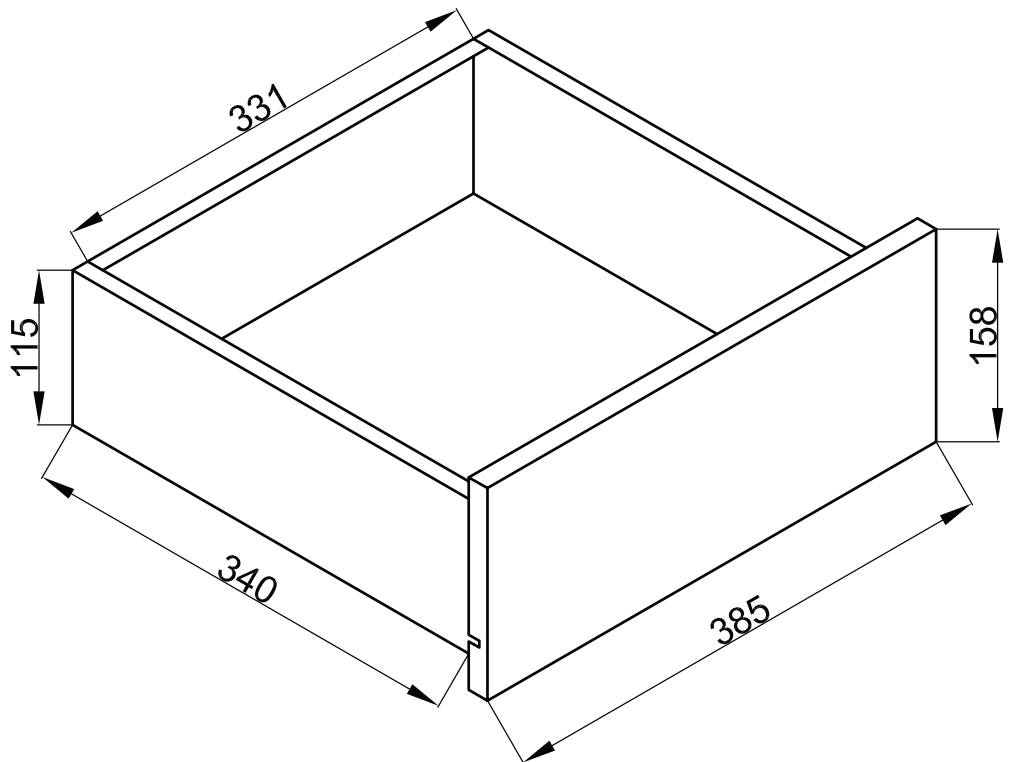
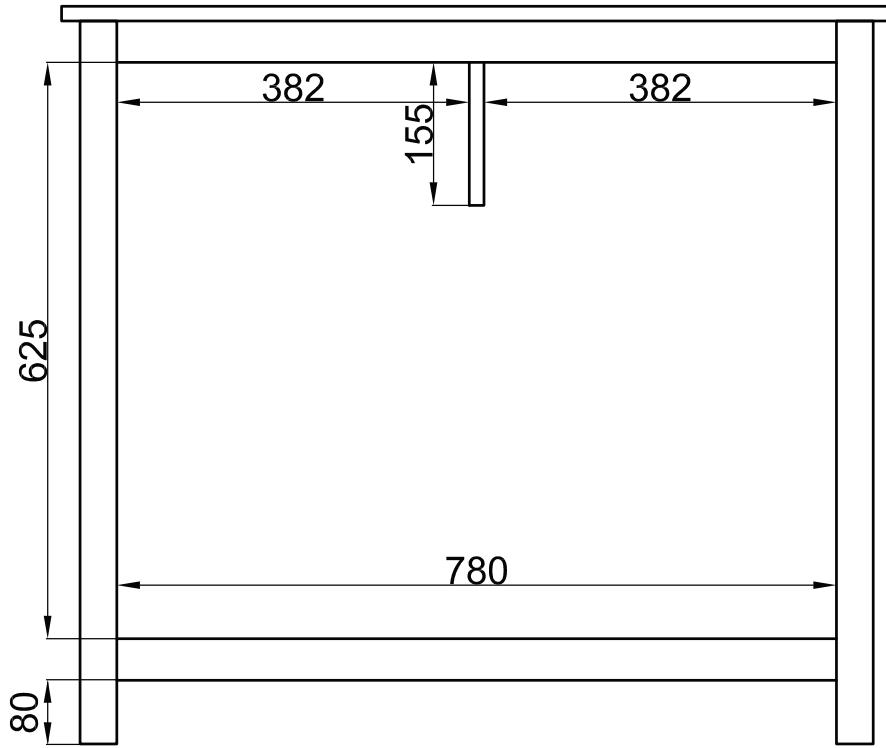

CAJA/COLIS 1/1	
1x PIECES 1	1x PIECES 12
1x PIECES 2	1x PIECES 13
1x PIECES 3	1x PIECES 14
2x PIECES 4	2x PIECES 15
1x PIECES 5	1x PIECES 16
1x PIECES 6	2x PIECES 17
1x PIECES 7	2x PIECES 18
1x PIECES 8	2x PIECES 19
2x PIECES 9	
2x PIECES 10	
2x PIECES 11	
QUINCALLERIE NOTICE DE MONTAGE	

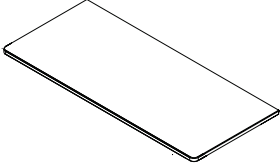
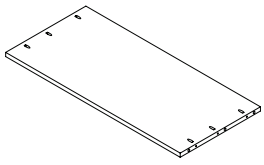
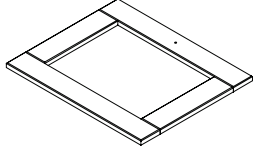
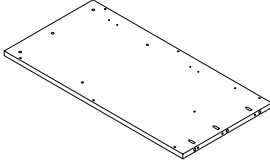
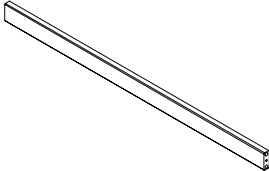
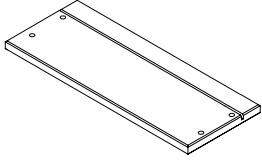
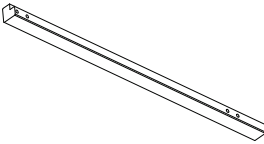
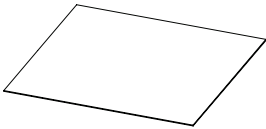
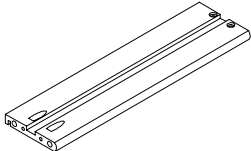
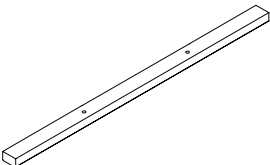
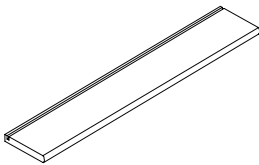
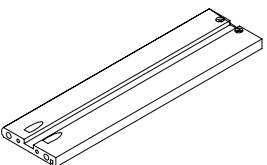
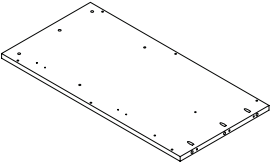
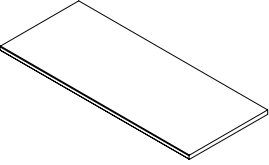
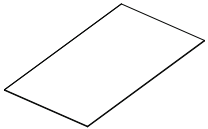
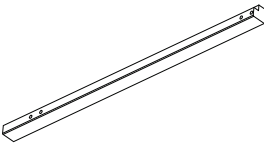
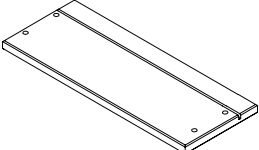
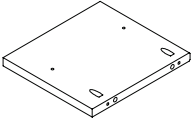
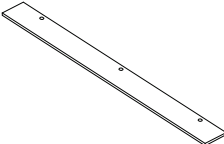



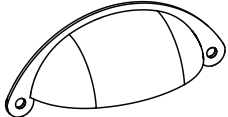
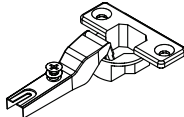
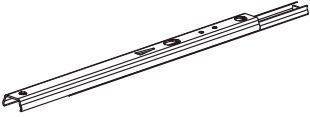
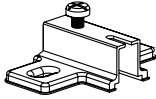
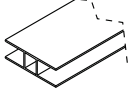

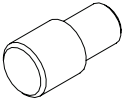

LISTADO DE PIEZAS - COMPOSANTS - PARTS LIST

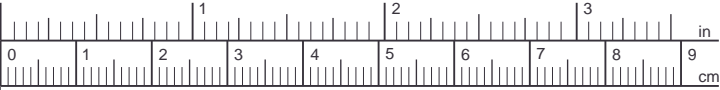
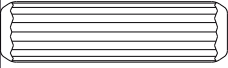
01		01pc	08		01pc	15		02pc
02		01pc	09		02pc	16		01pc
03		01pc	10		02pc	17		02pc
04		02pc	11		02pc	18		02pc
05		01pc	12		01pc	19		02pc
06		01pc	13		01pc			
07		01pc	14		01pc			

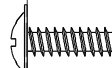
HERRAJES - QUINCALLERIE - HARDWARE

G		02	M		04
H		04	N		04
I		01	Q		02
K		04			
L		01			

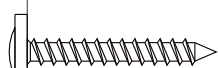
			
A x34		8,0x30	
B x46		4,0x30	
C x08		6,0x10	
D x04		M4x12	
E x02		M4x22	
F x38		1,8x20	
J x25		3,5X14	
T x04		4,0x30	

01

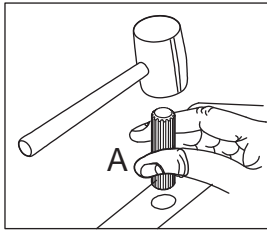
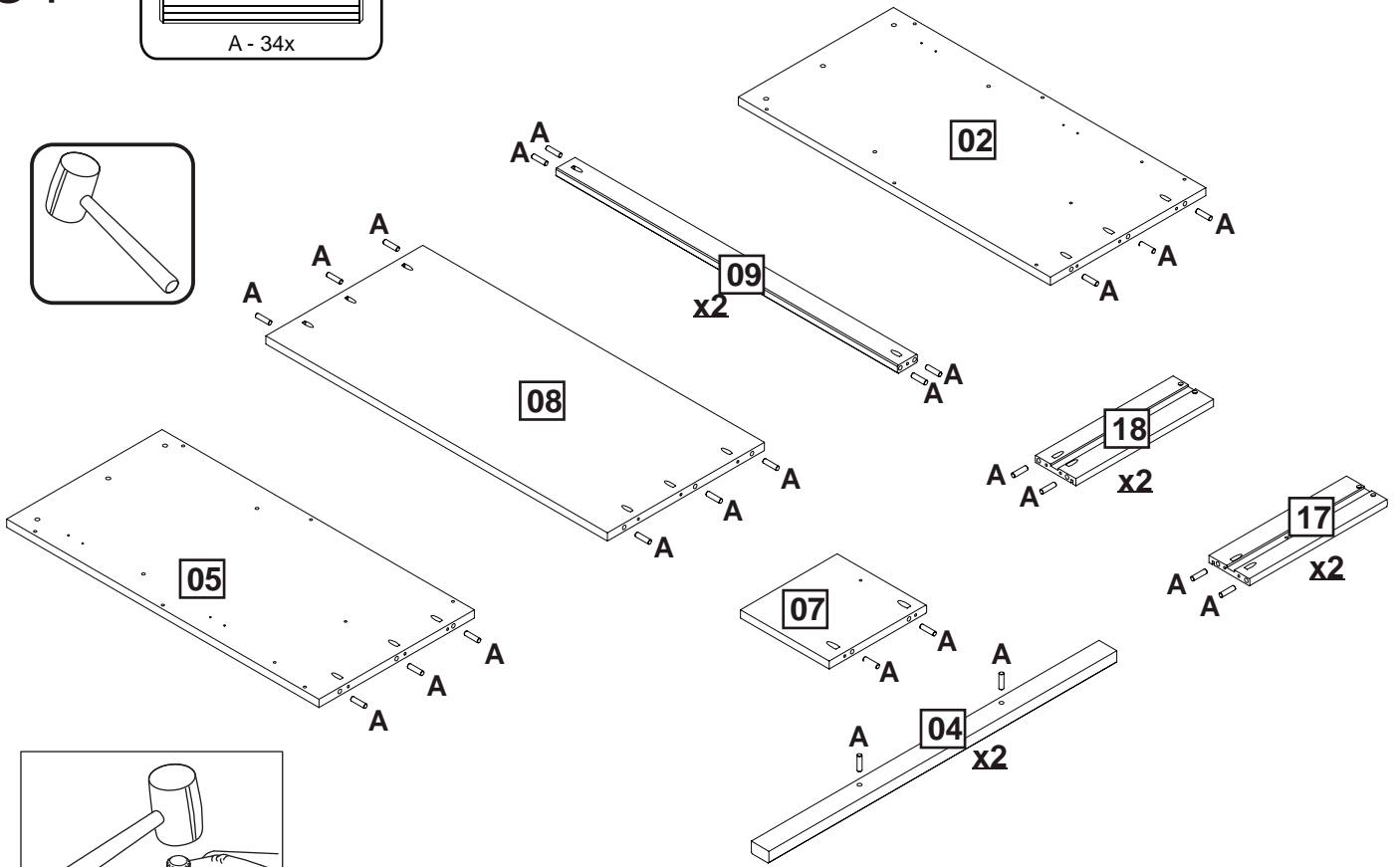
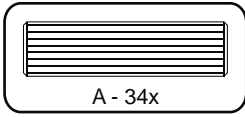

02

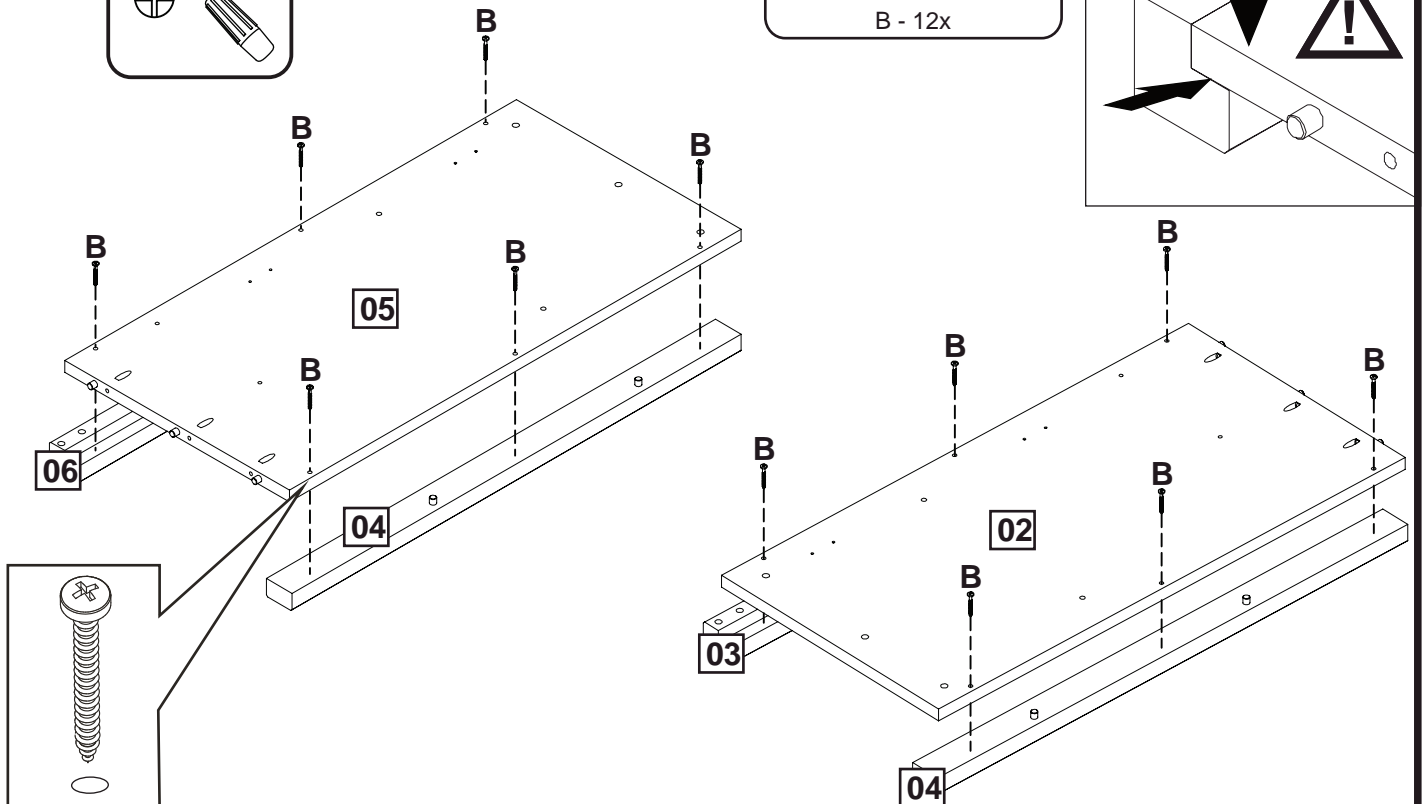
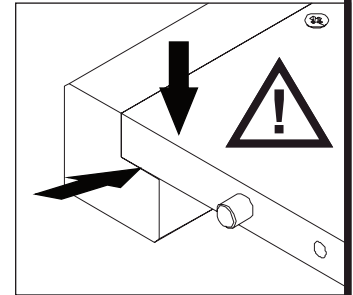
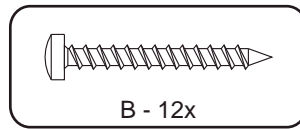

03

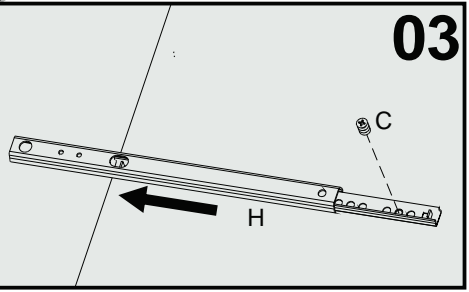
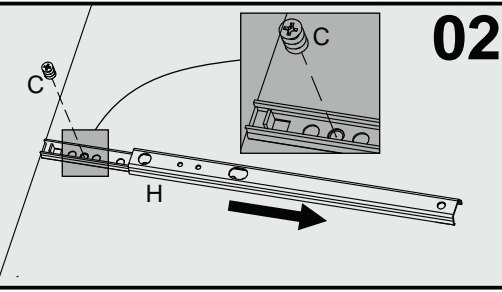
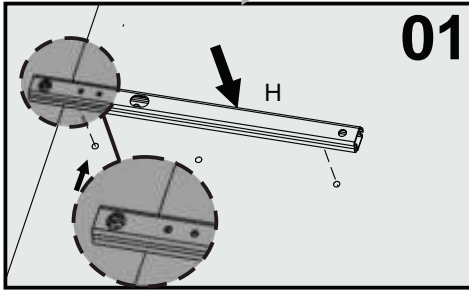
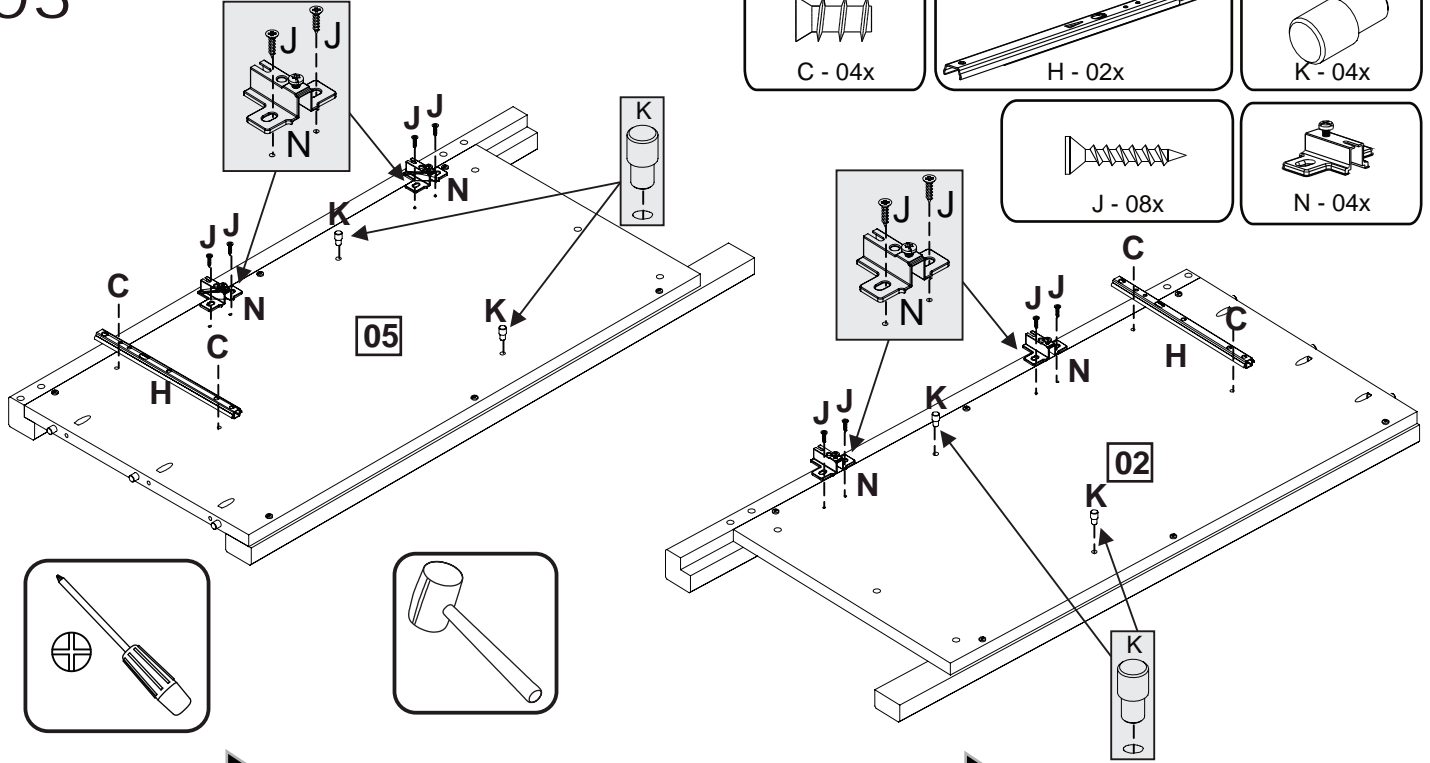
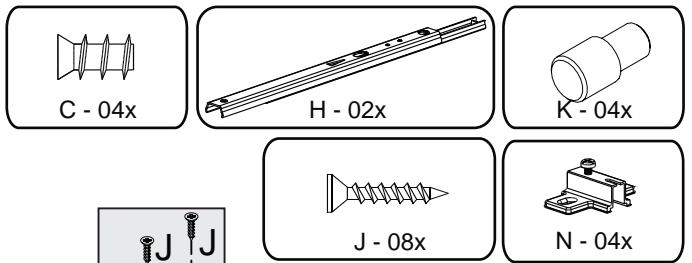

04

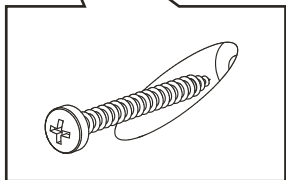
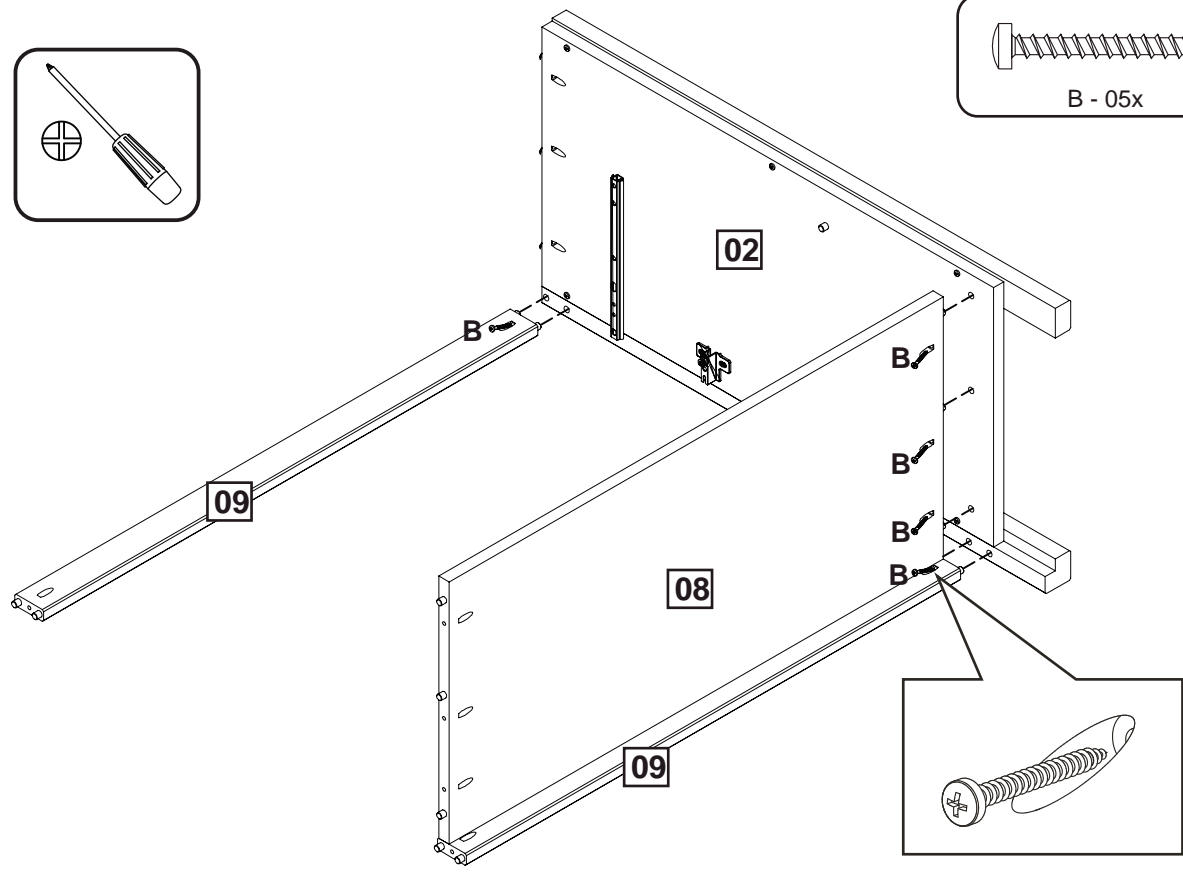
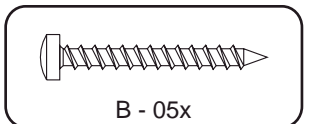

05

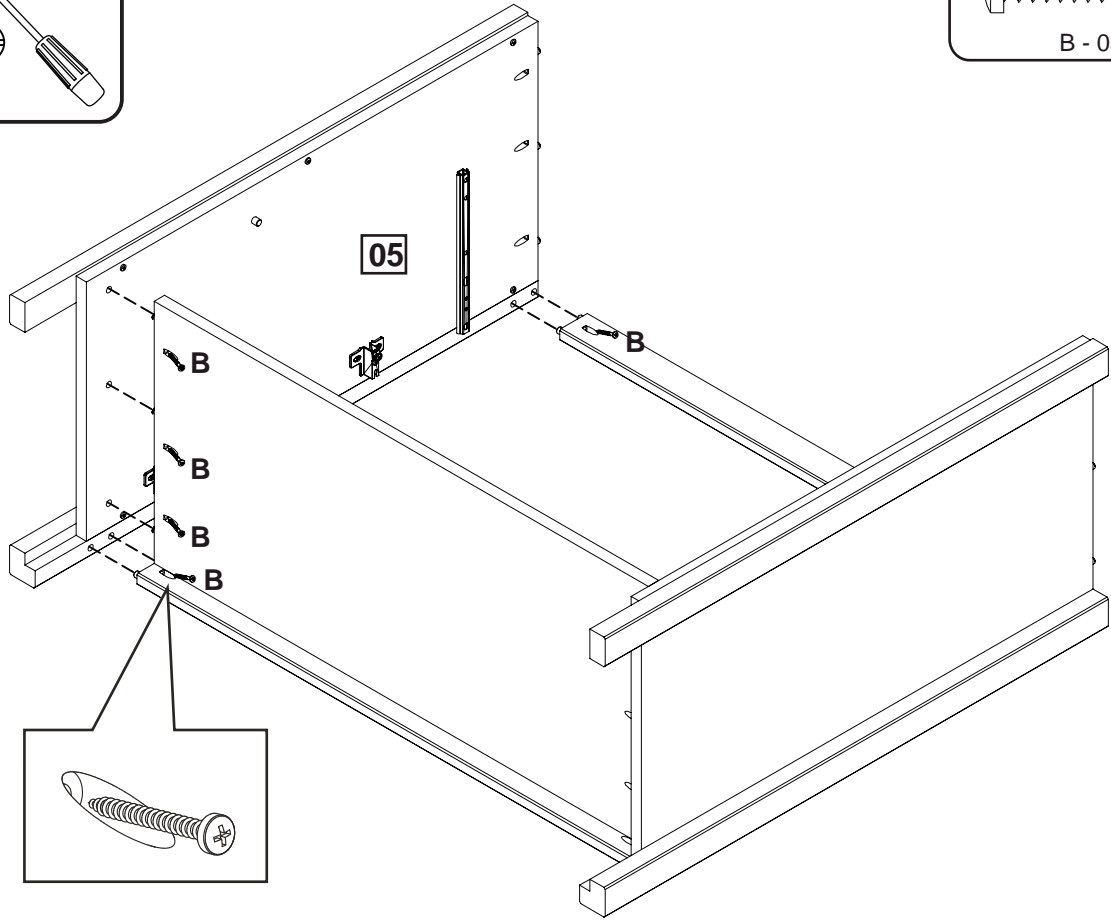
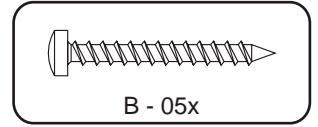
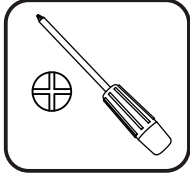

06

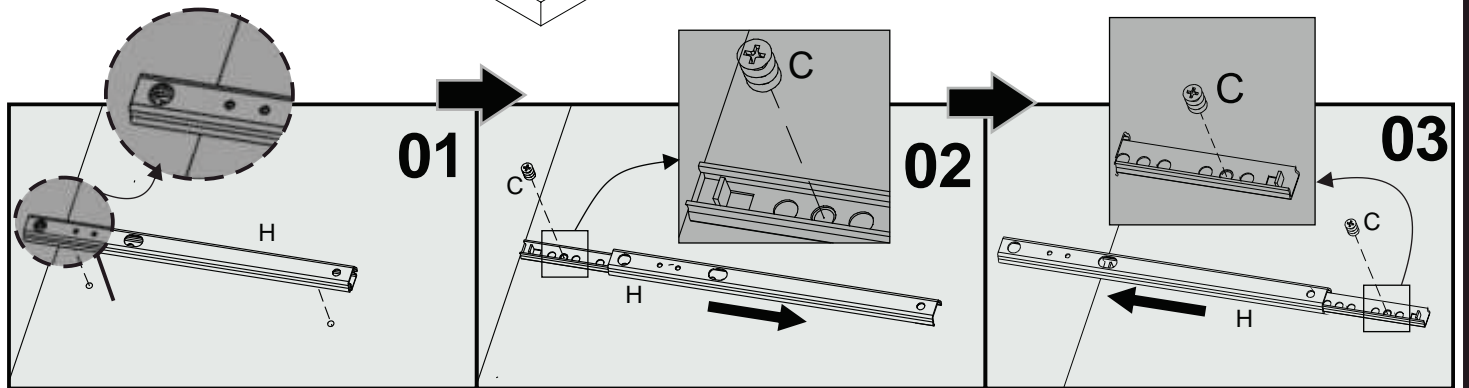
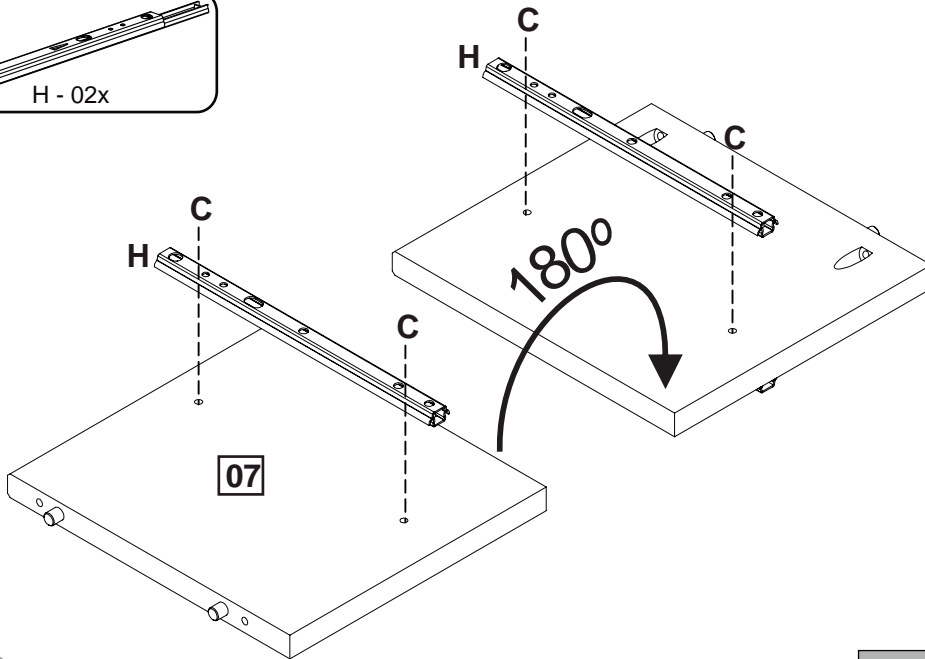
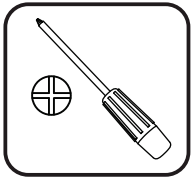
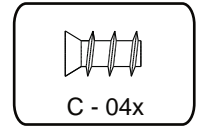
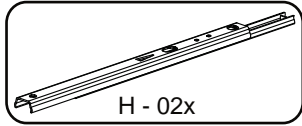

07

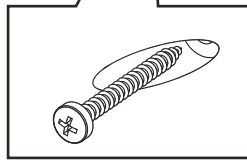
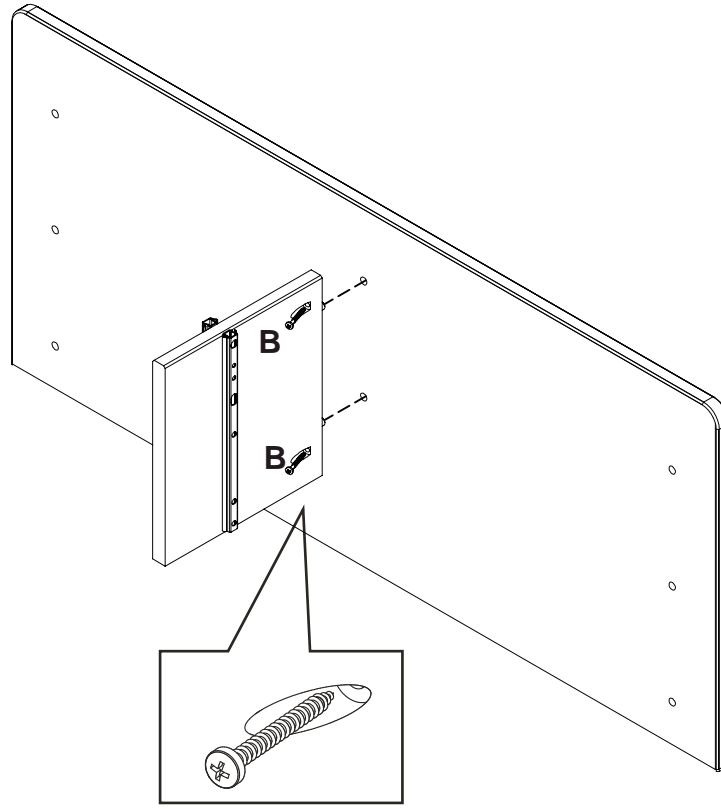
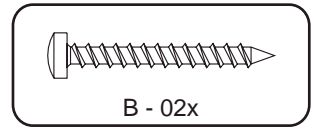
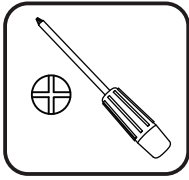

08

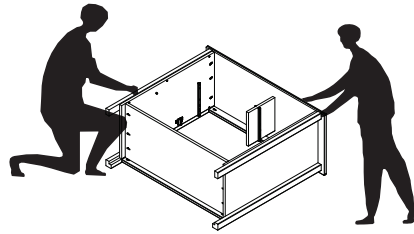
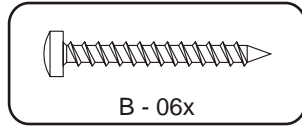
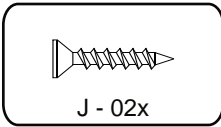
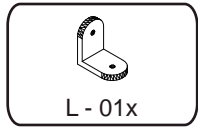
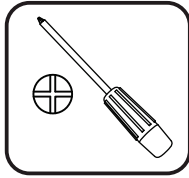

FRENCH: Basculer le meuble avec précaution. Utilisez une couverture recommandée pour ne pas abîmer le meuble.

SPANISH: Girar el mueble con cuidado. Utilice un cobertor para evitar daños en el mueble.

ENGLISH: Turn the furniture carefully. Use a cover to avoid damage to the furniture.

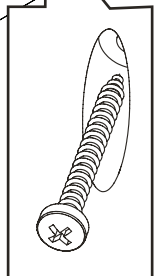
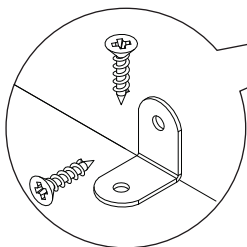
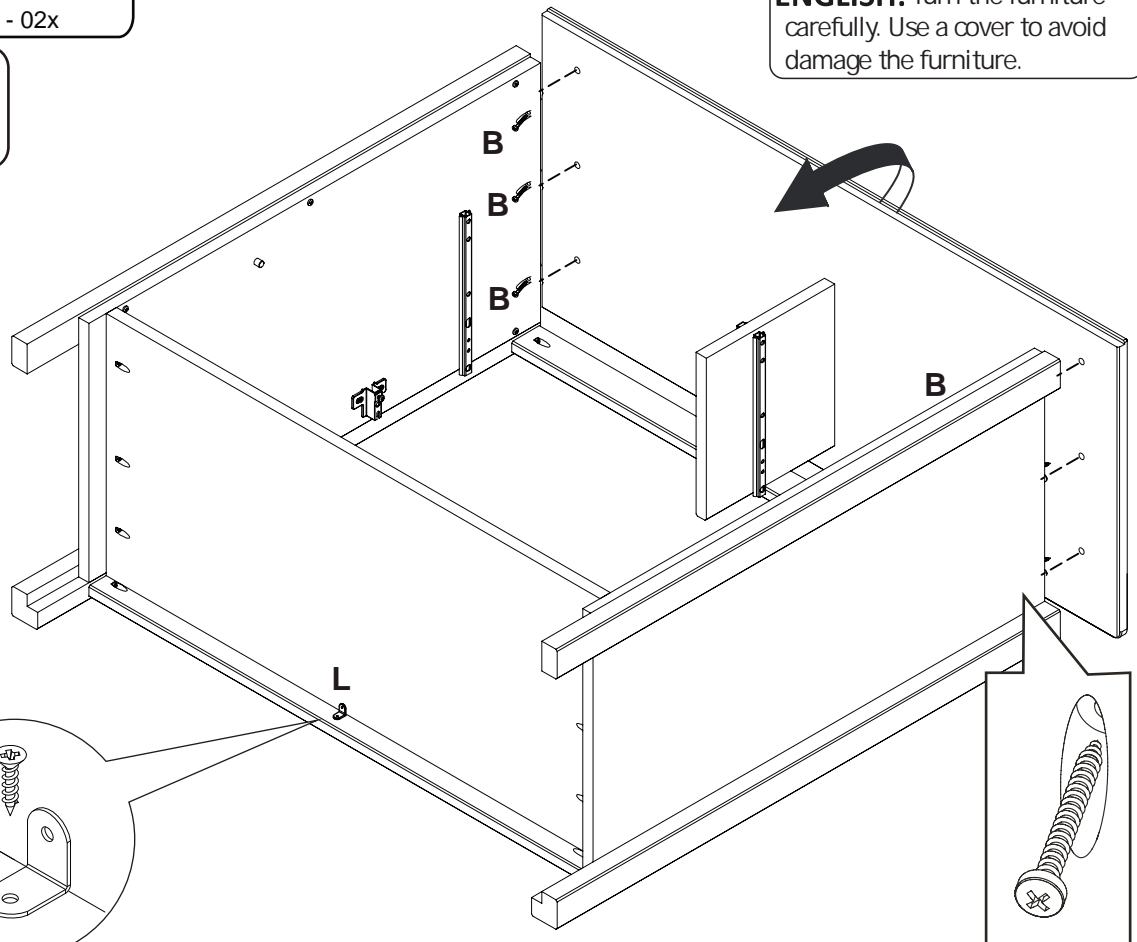

09

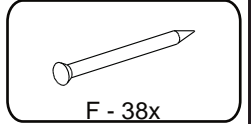
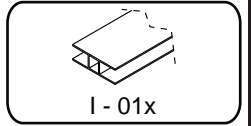
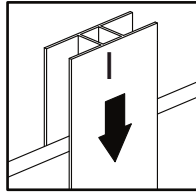

FRENCH: Basculer le meuble avec précaution. Utilisez une couverture recommandée pour ne pas abîmer le meuble.

SPANISH: Girar el mueble con cuidado. Utilice un cobertor para evitar daños en el mueble.

ENGLISH: Turn the furniture carefully. Use a cover to avoid damage to the furniture.

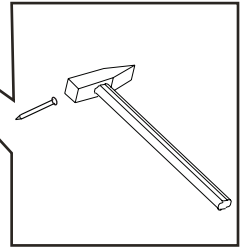
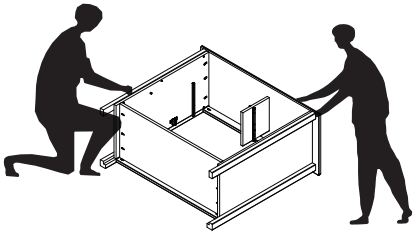
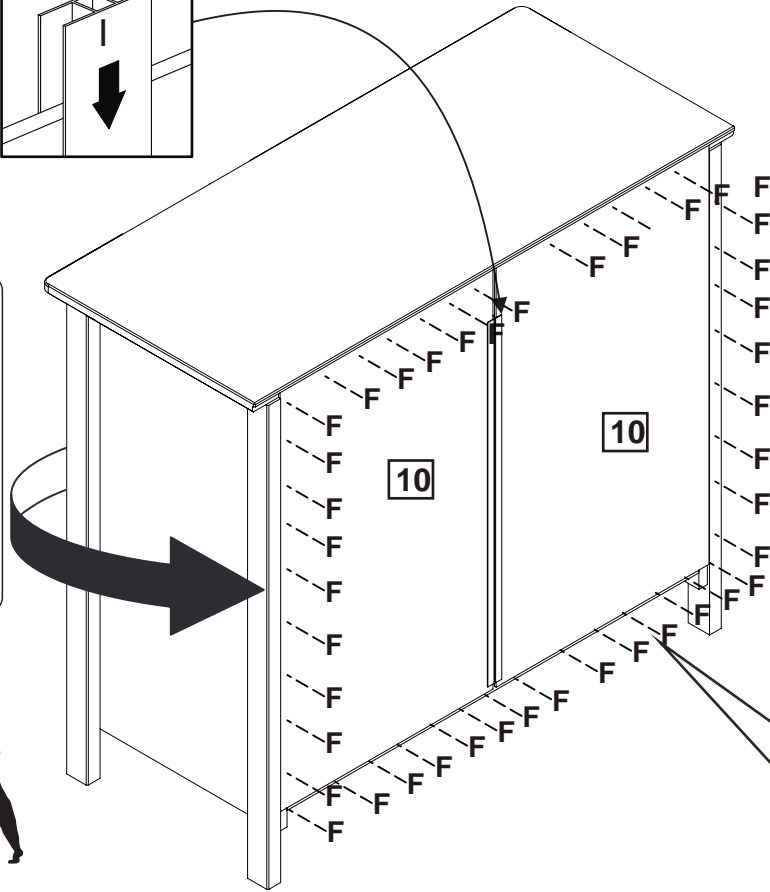

10

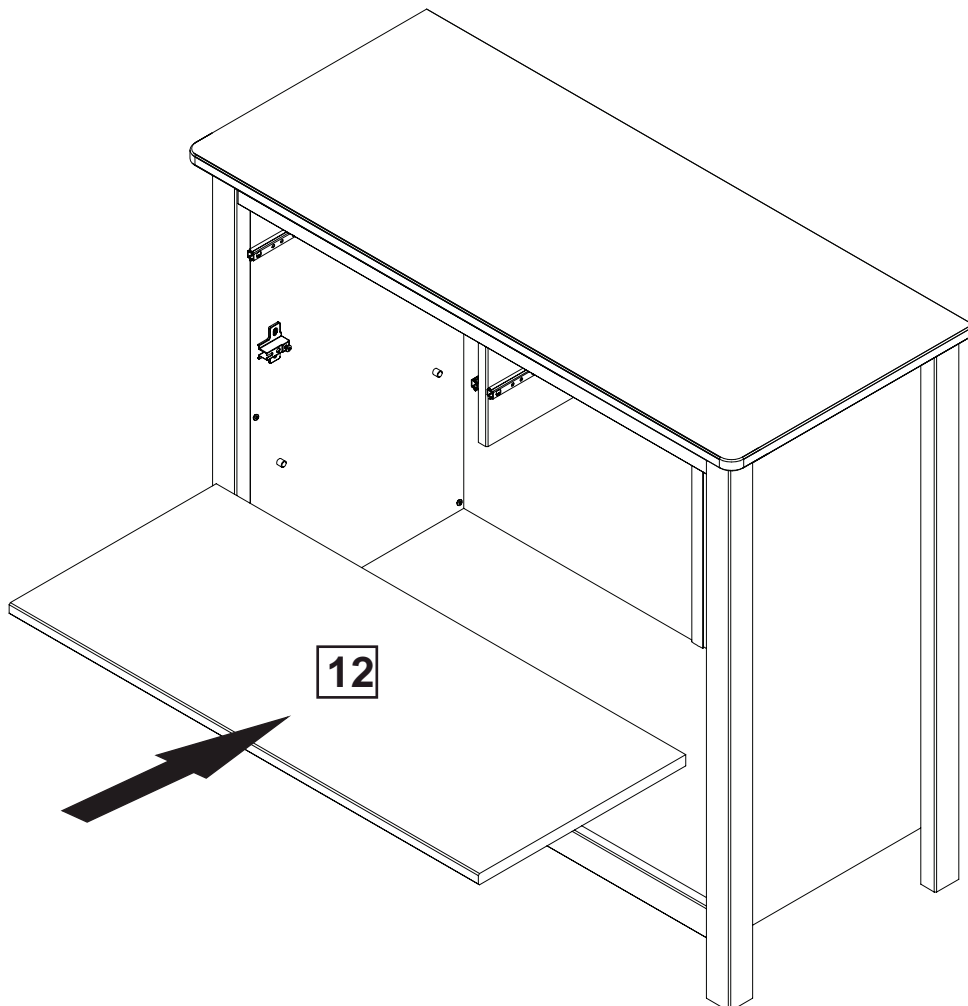

11

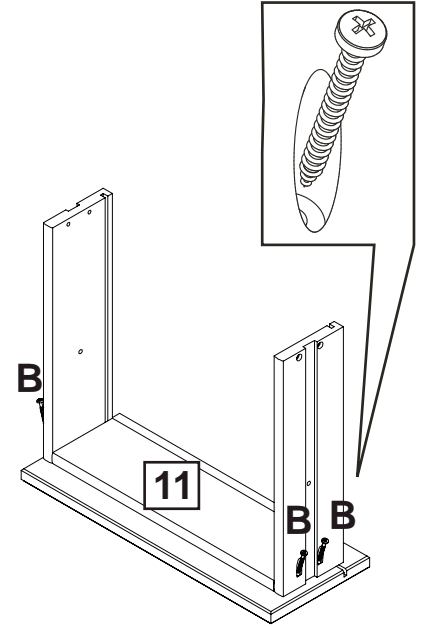
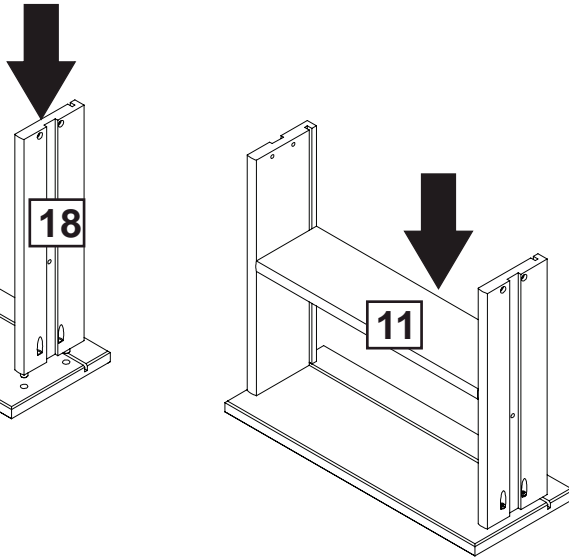
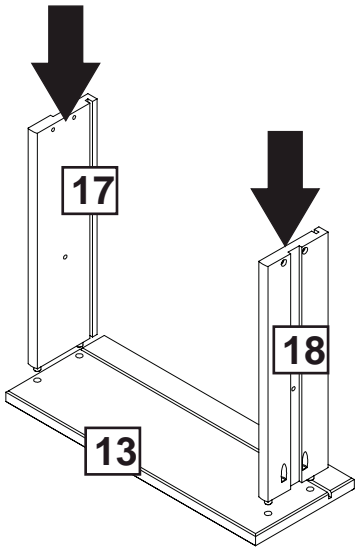
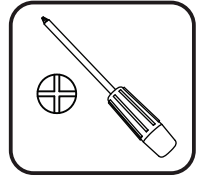
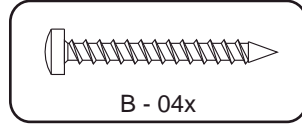

12

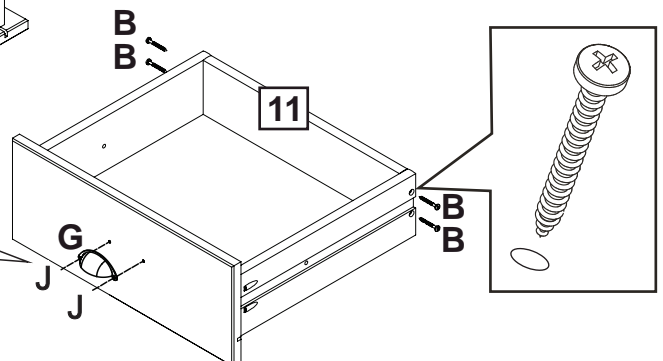
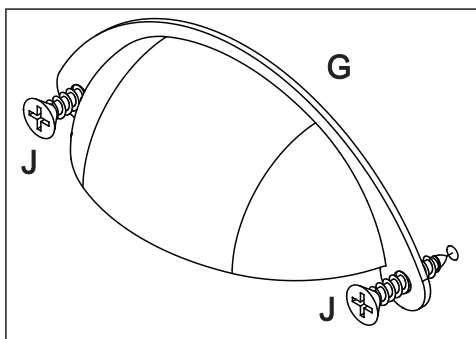
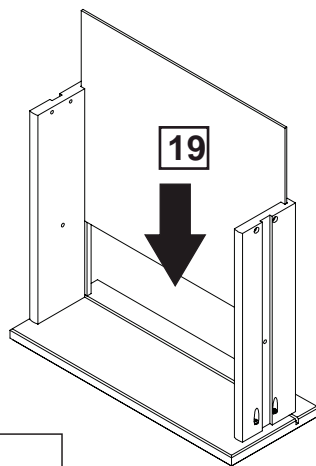
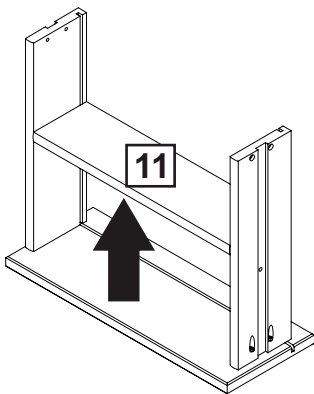
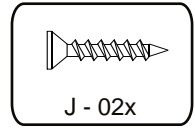
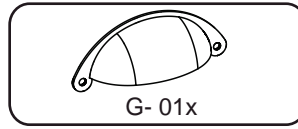
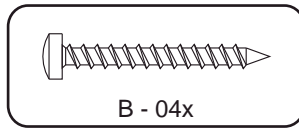

13

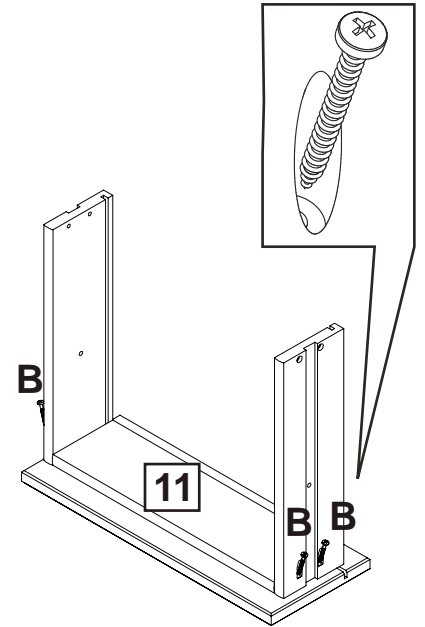
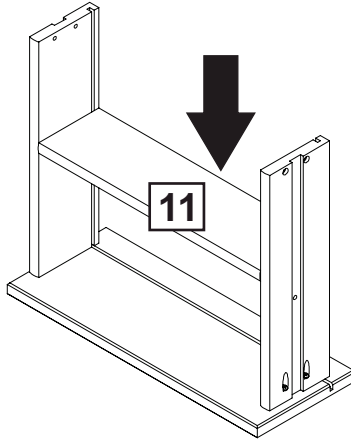
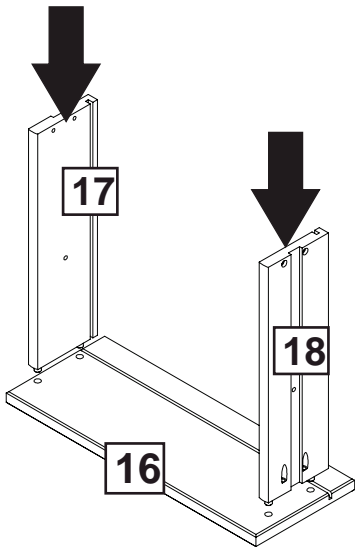
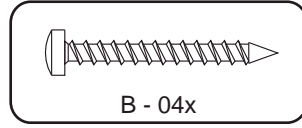

14

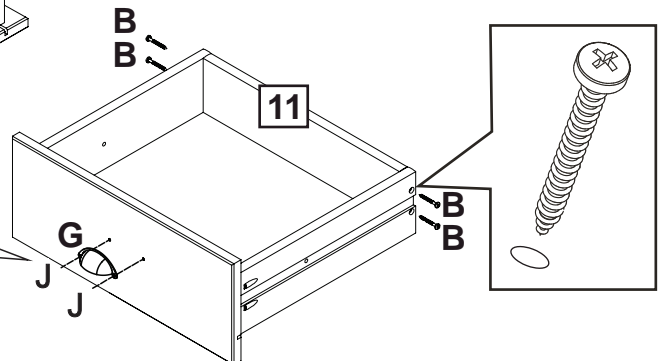
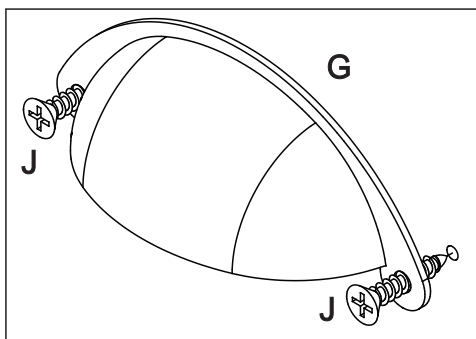
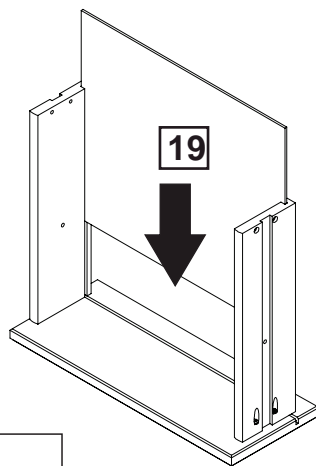
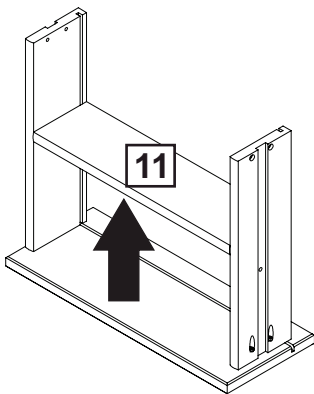
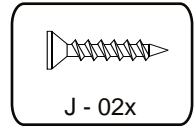
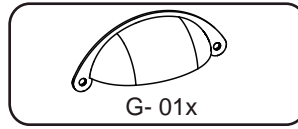
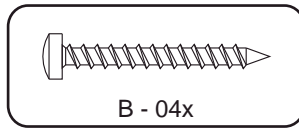

15

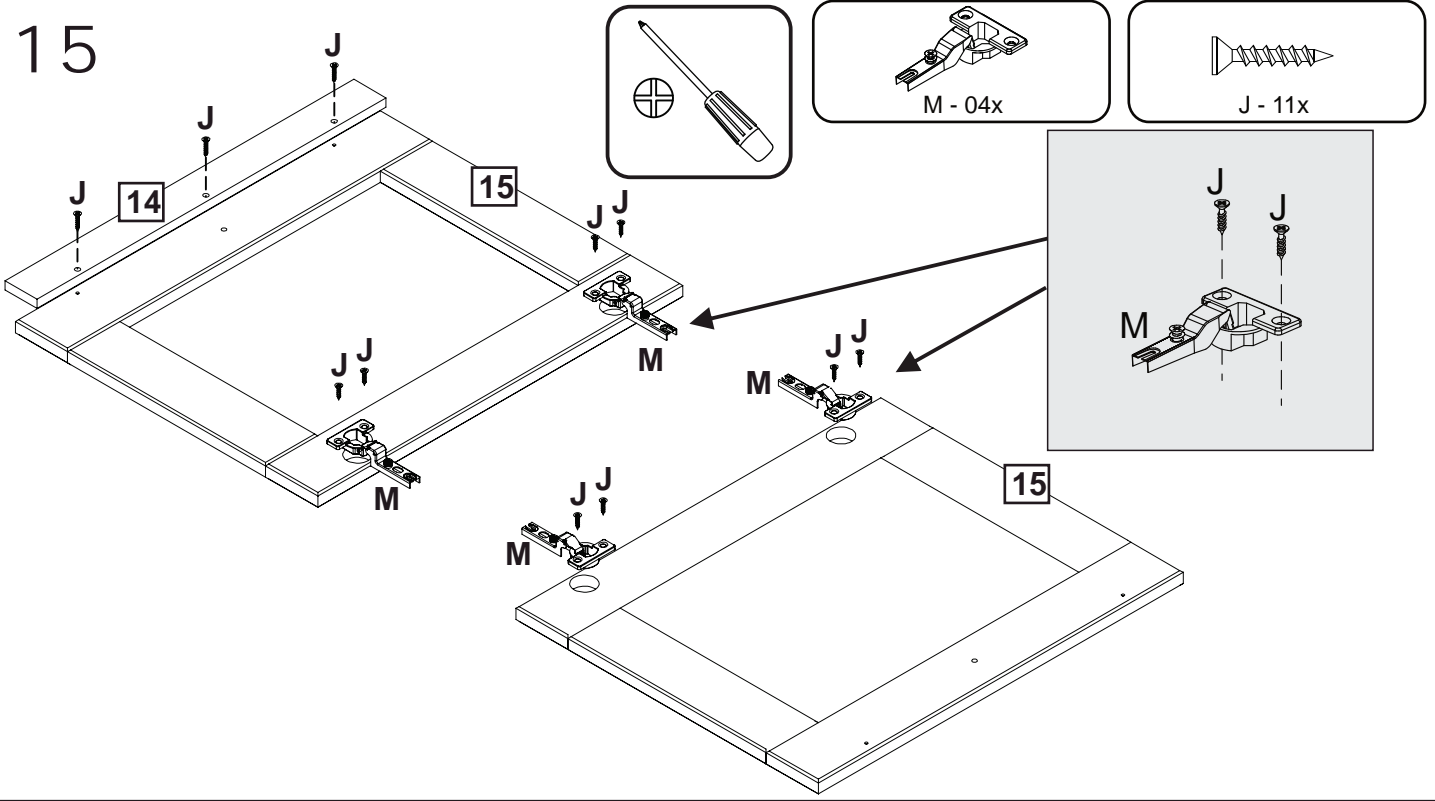

16

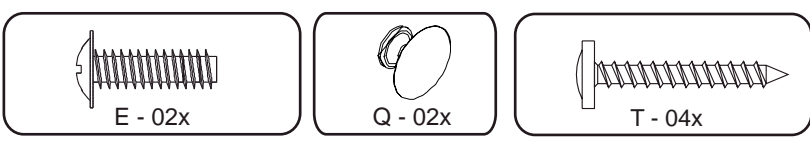
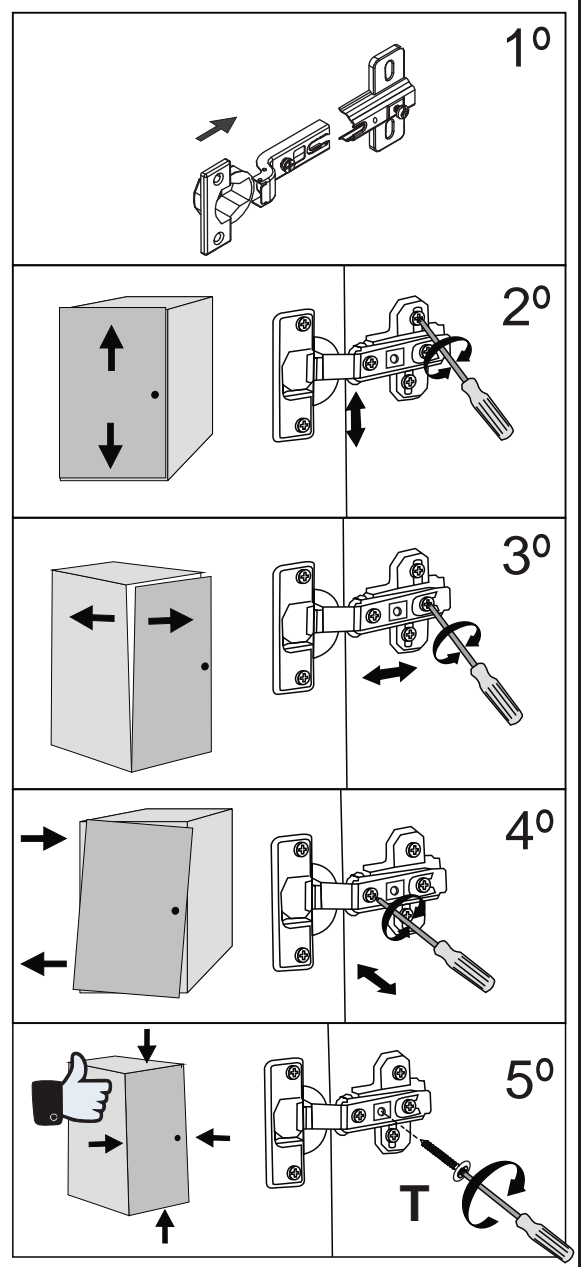
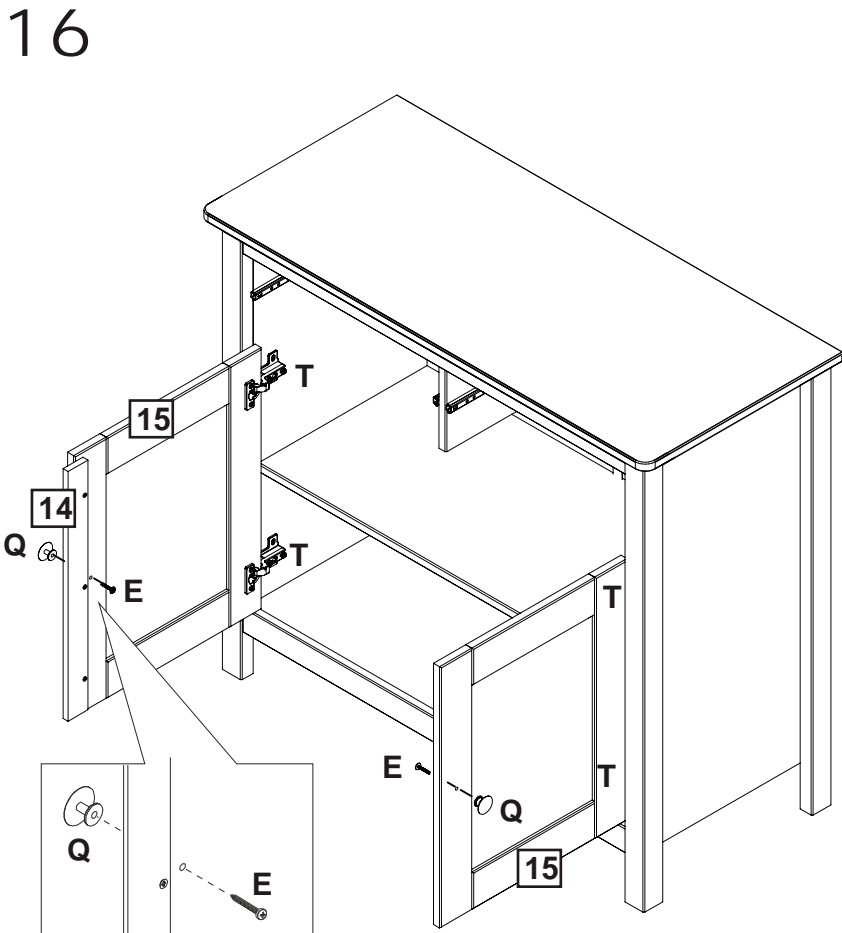

17

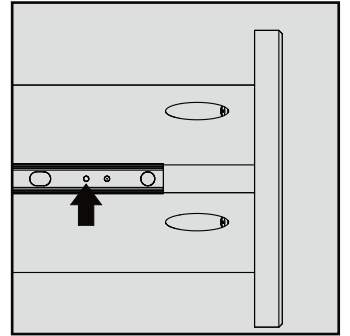
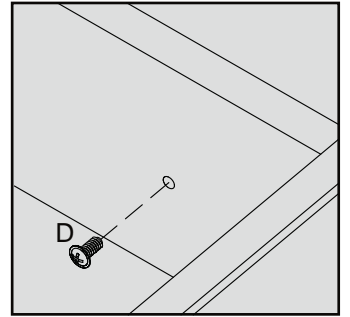
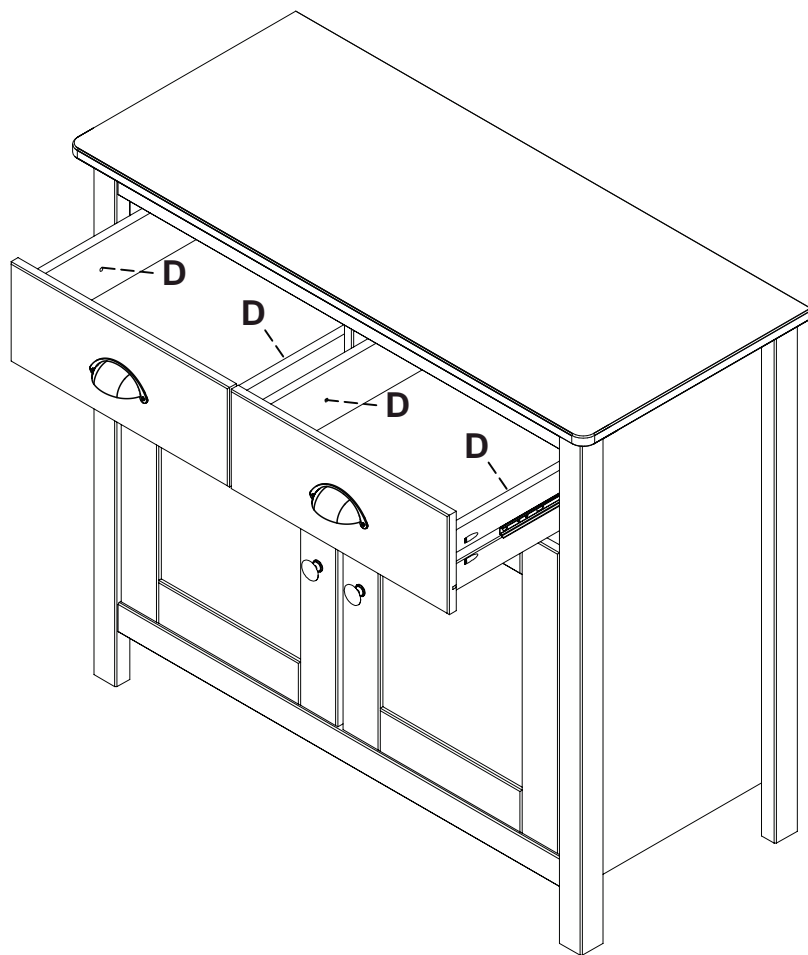
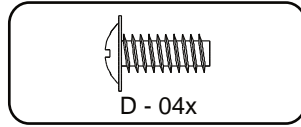
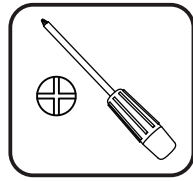

CAJA-COLIS 2/2
 - COMPLETE SUPERIOR
 BUFFET
 - QUINCALLERIE

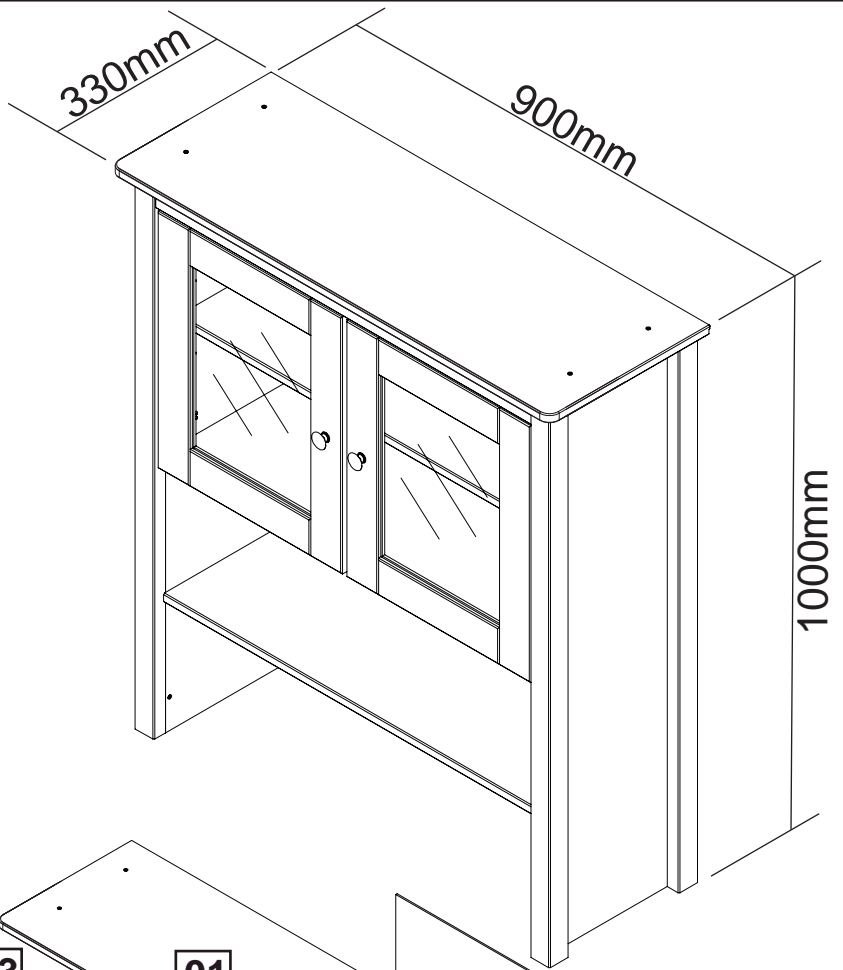

CAJA/COLIS 2/2

- 1x PIECES 1
- 1x PIECES 2
- 2x PIECES 3
- 1x PIECES 4
- 1x PIECES 5
- 1x PIECES 6
- 1x PIECES 7
- 1x PIECES 8
- 1x PIECES 9
- 1x PIECES 10
- 1x PIECES 11
- 1x PIECES 12
- 1x PIECES 13
- 1x PIECES 14
- 1x PIECES 15
- 2x PIECES 16
- 1x PIECES 17

QUINCALLERIE
 NOTICE DE
 MONTAGE

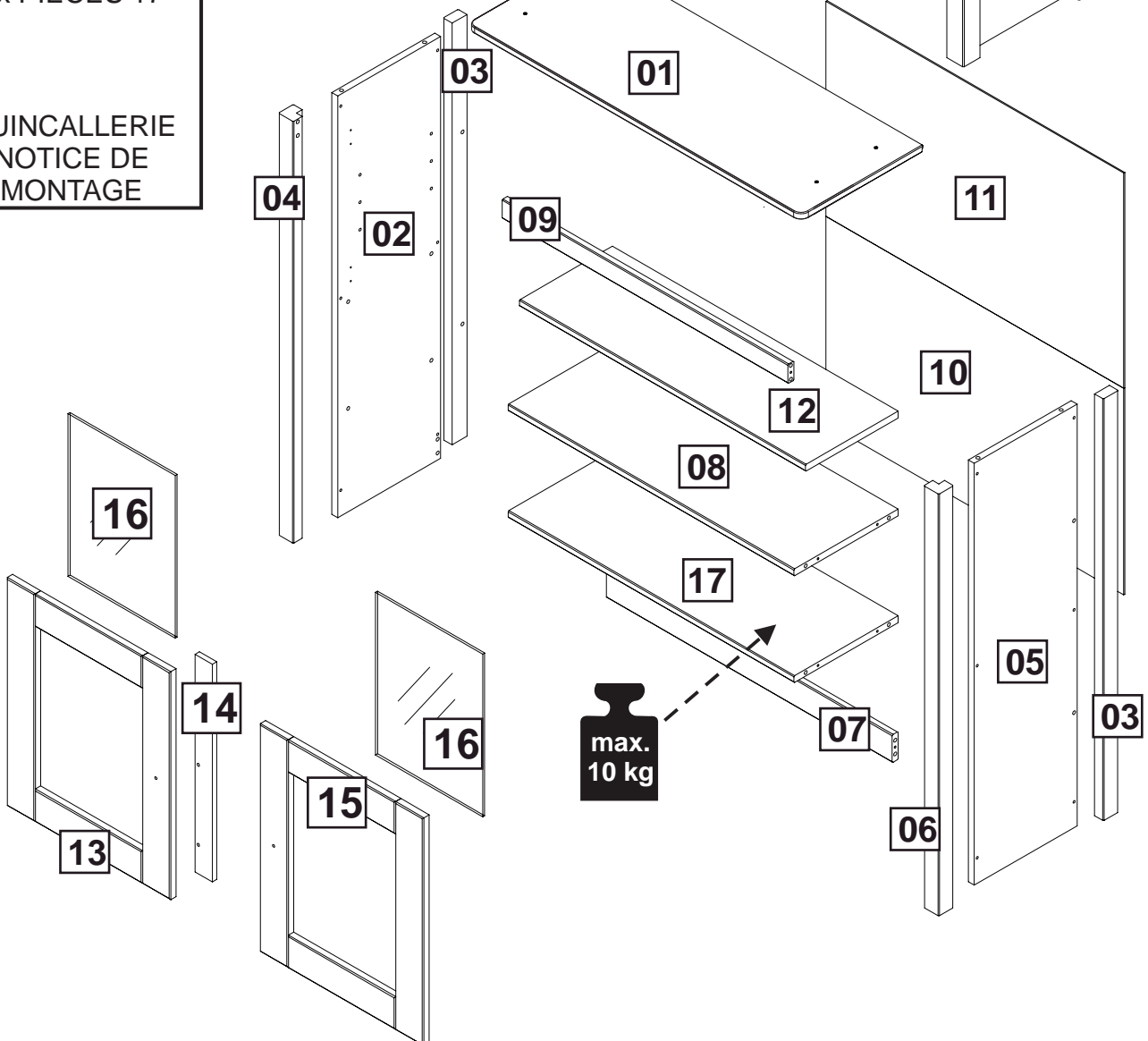

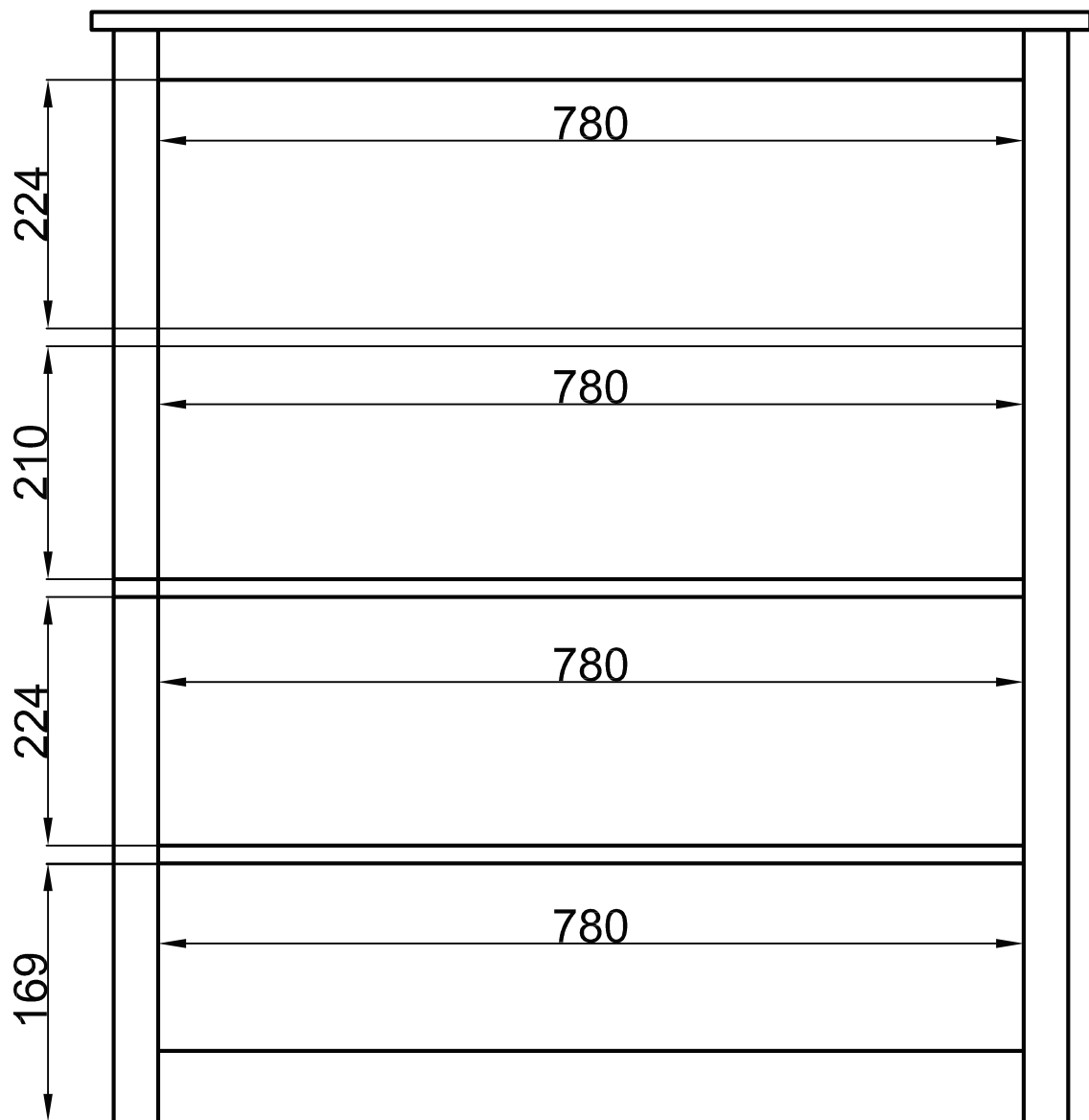



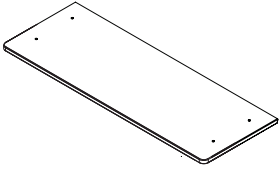
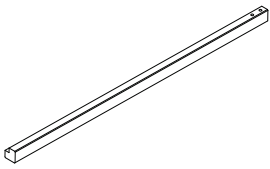
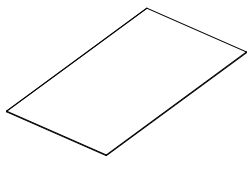
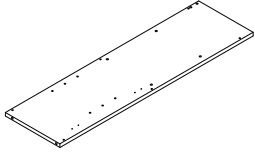
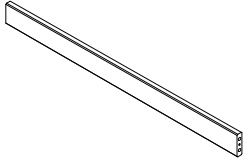
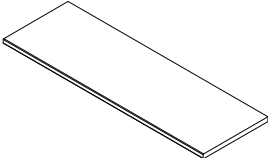
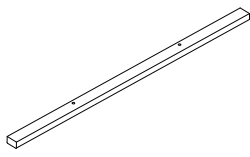
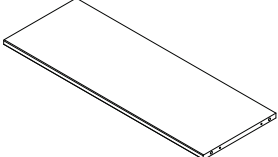
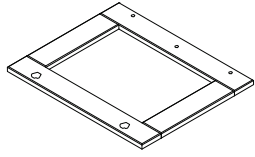
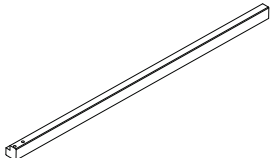
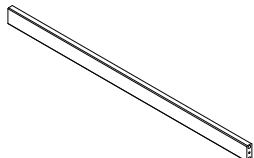
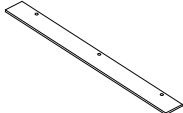
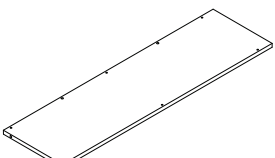
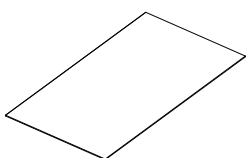
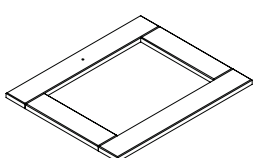
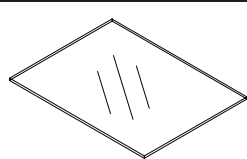
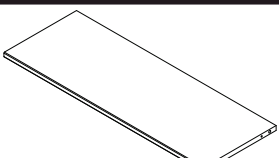



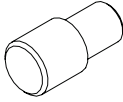

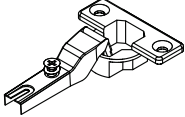
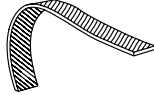
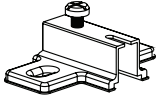
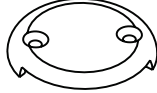

LISTADO DE PIEZAS - COMPOSANTS - PARTS LIST

01		01pc	06		01pc	11		01pc
02		01pc	07		01pc	12		01pc
03		02pc	08		01pc	13		01pc
04		01pc	09		01pc	14		01pc
05		01pc	10		01pc	15		01pc
						16		02pc
						17		01pc

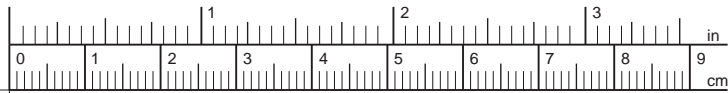
HERRAJES QUINCALLERIE HARDWARE

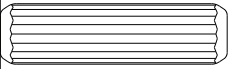
E		04	J		02
F		48	L		02
G		02	M		02
H		04	N		01
I		04	P		08

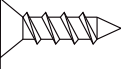
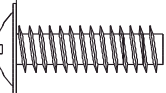

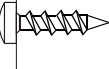
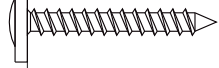
A x24		8,0x30
B x16		4,0x30
C x24		3,5x14
D x02		M4x22
K x12		4,0x30
O x16		3,0x12
Q x04		4,0x30

01

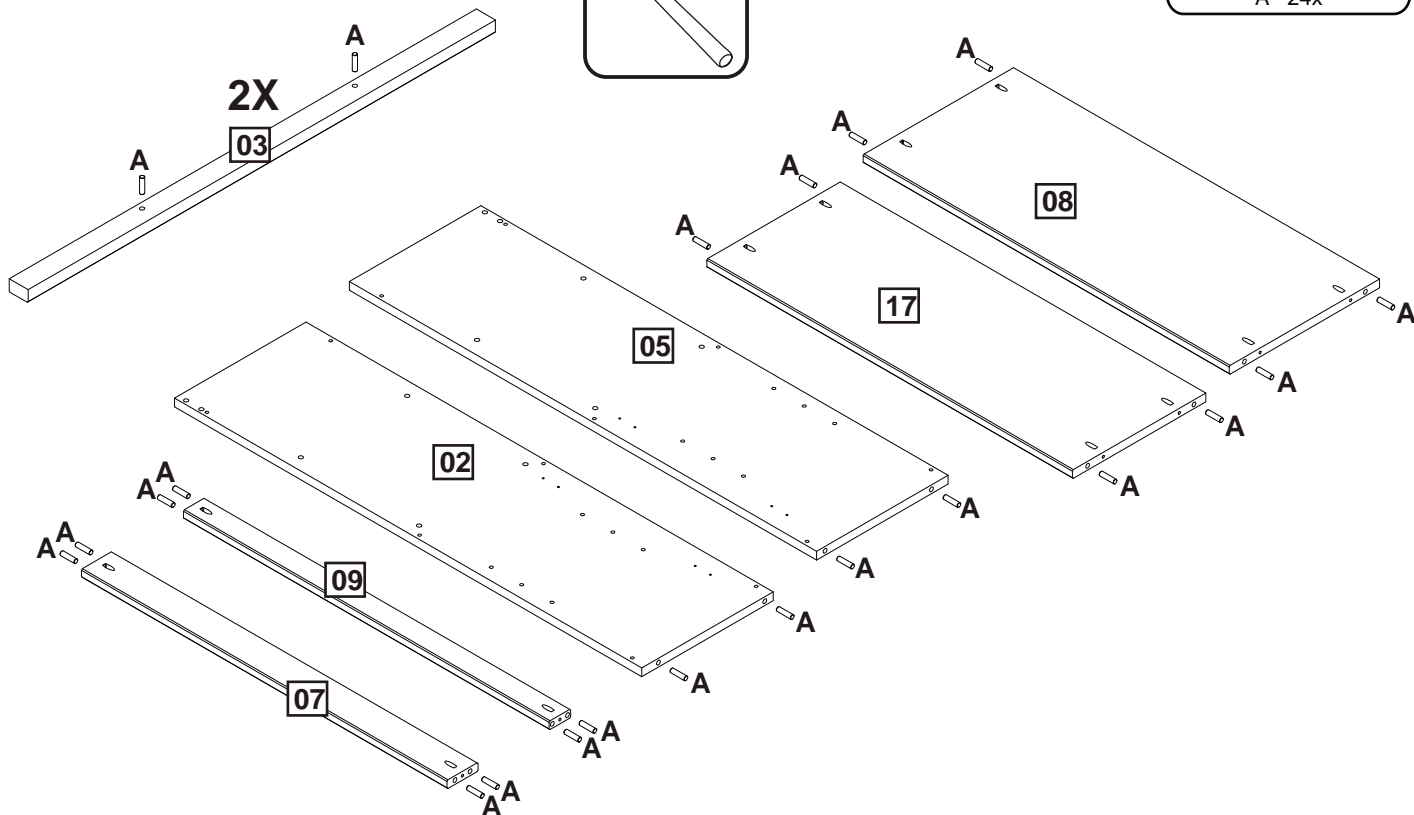
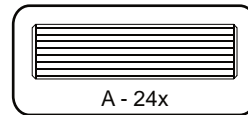

02

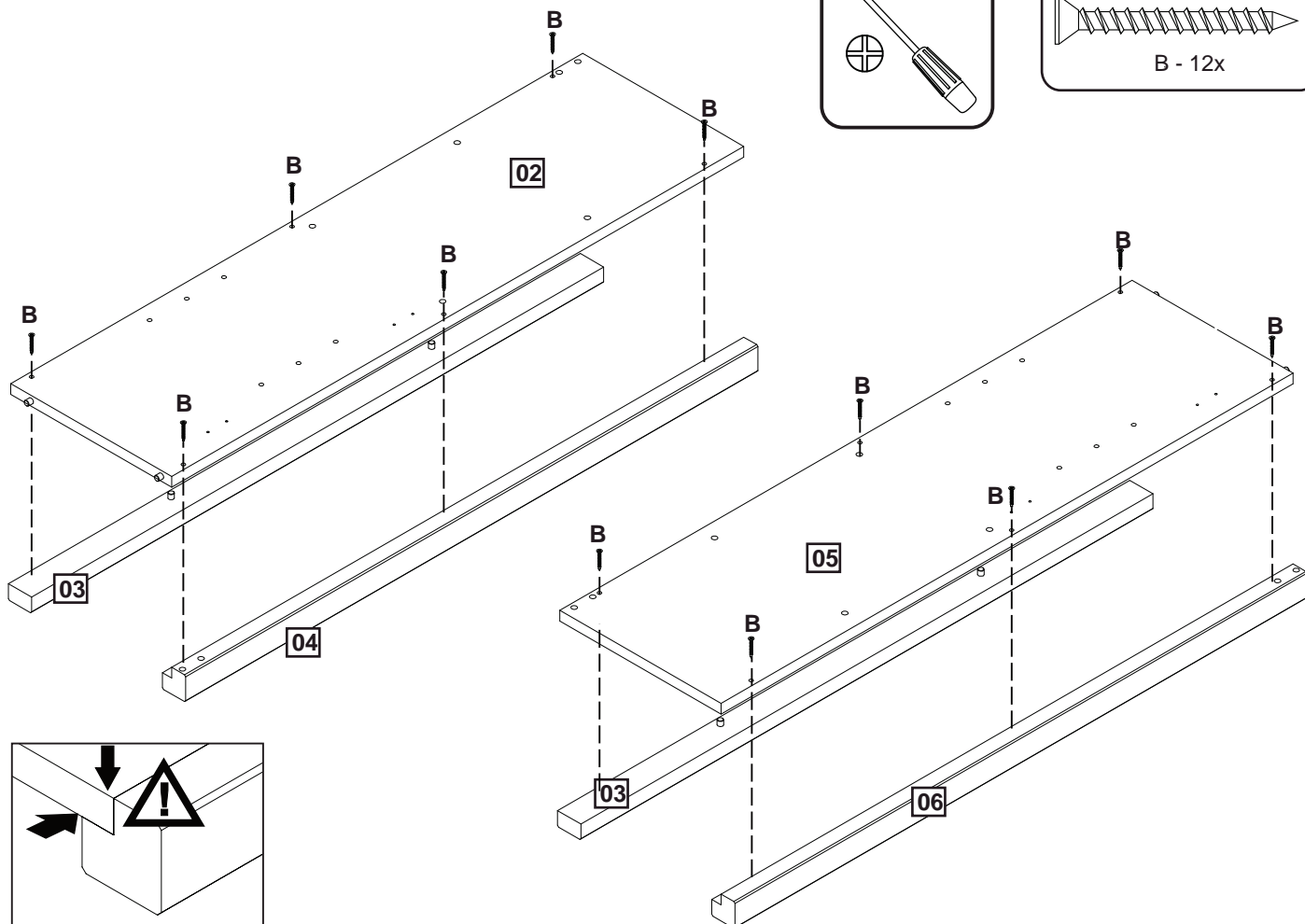
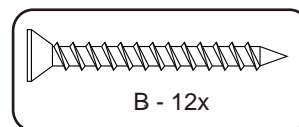
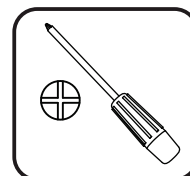

03

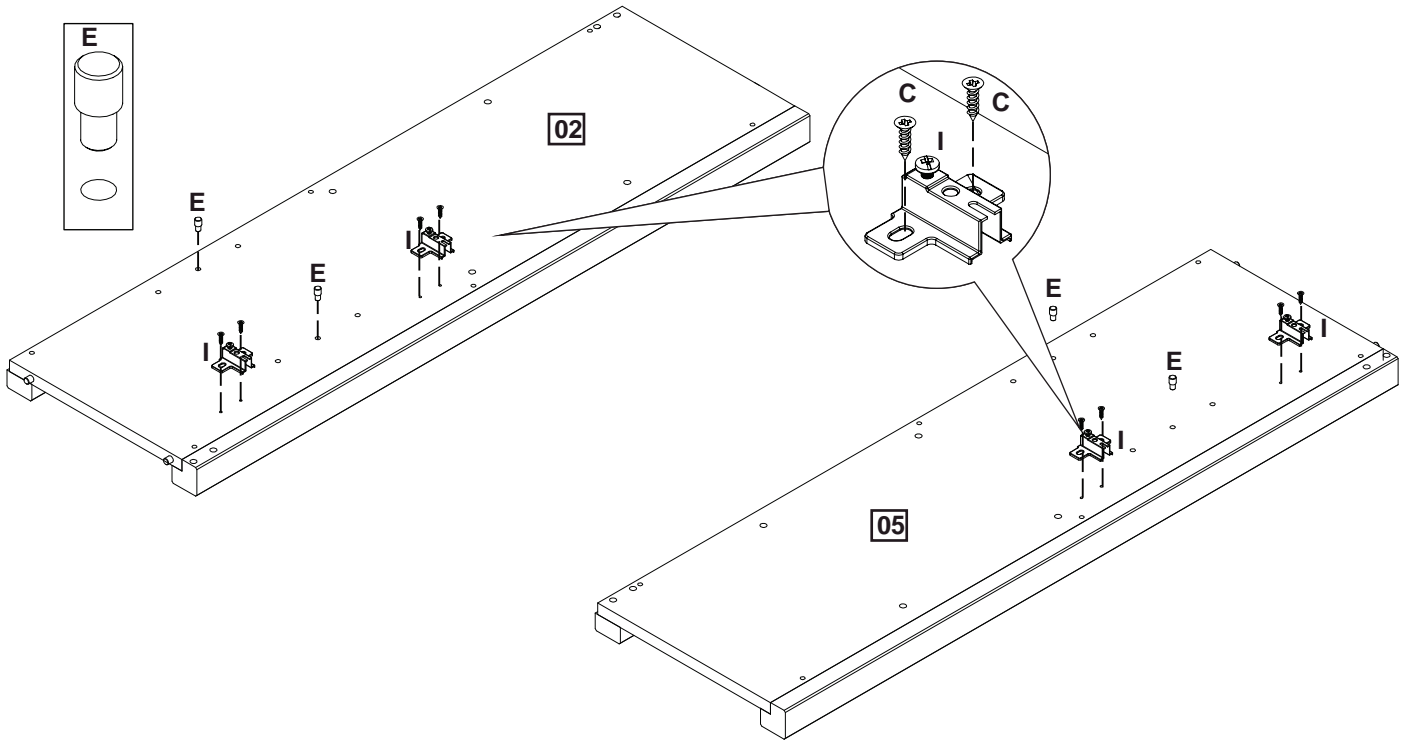
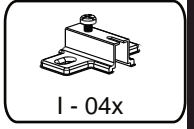
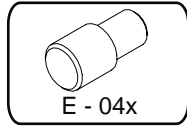
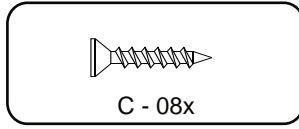
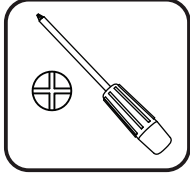

04

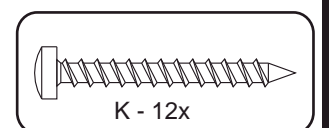
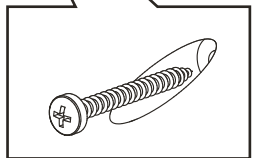
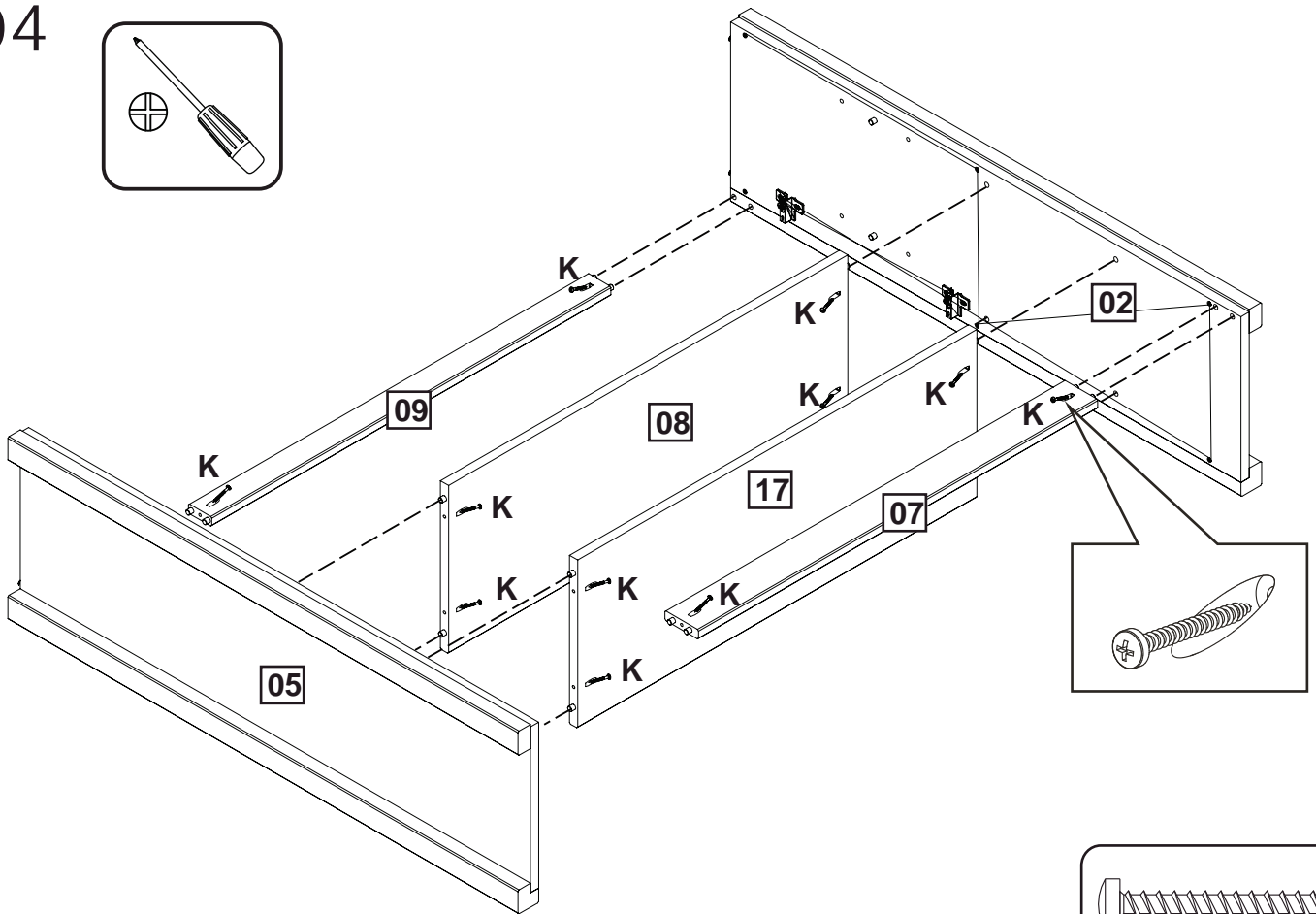
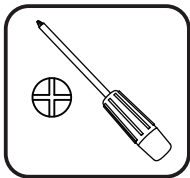

05

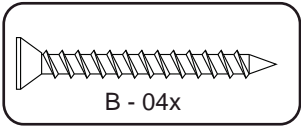
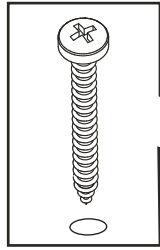
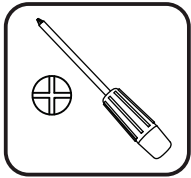

B

B

01

02

05

FRENCH: Basculer le meuble avec précaution. Utilisez une couverture recommandée pour ne pas abîmer le meuble.

SPANISH: Girar el mueble con cuidado. Utilice un cobertor para evitar daños en el mueble.

ENGLISH: Turn the furniture carefully. Use a cover to avoid damage the furniture.

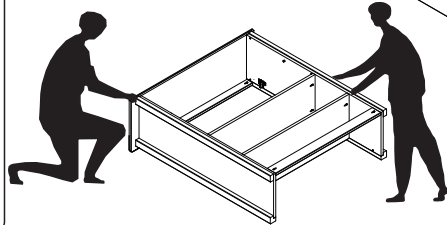

06

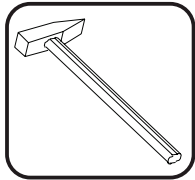

FRENCH: Basculer le meuble avec précaution. Utilisez une couverture recommandée pour ne pas abîmer le meuble.

SPANISH: Girar el mueble con cuidado. Utilice un cobertor para evitar daños en el mueble.

ENGLISH: Turn the furniture carefully. Use a cover to avoid damage the furniture.

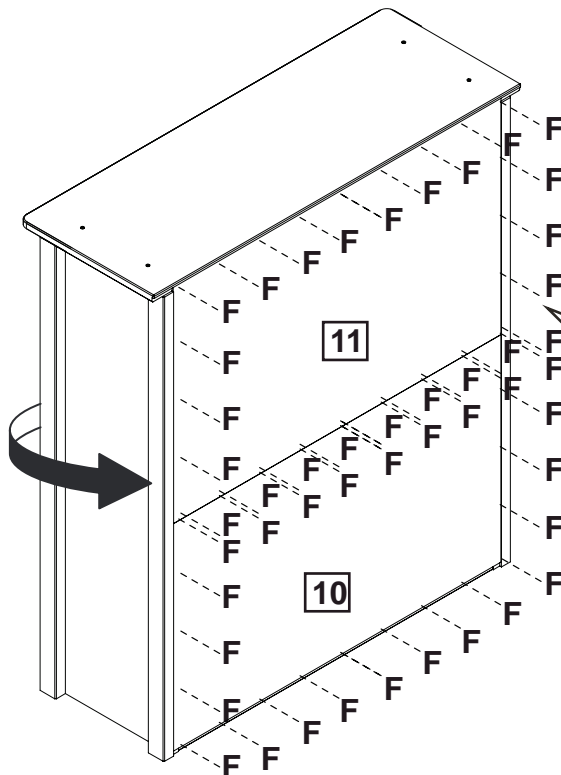

11

10

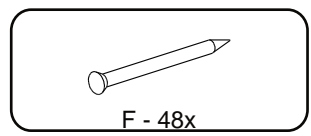
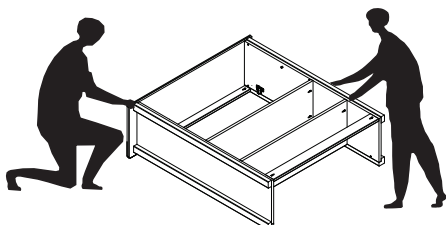
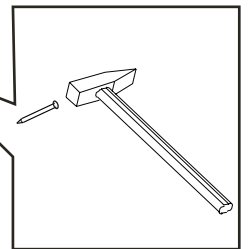

F - 48x

07

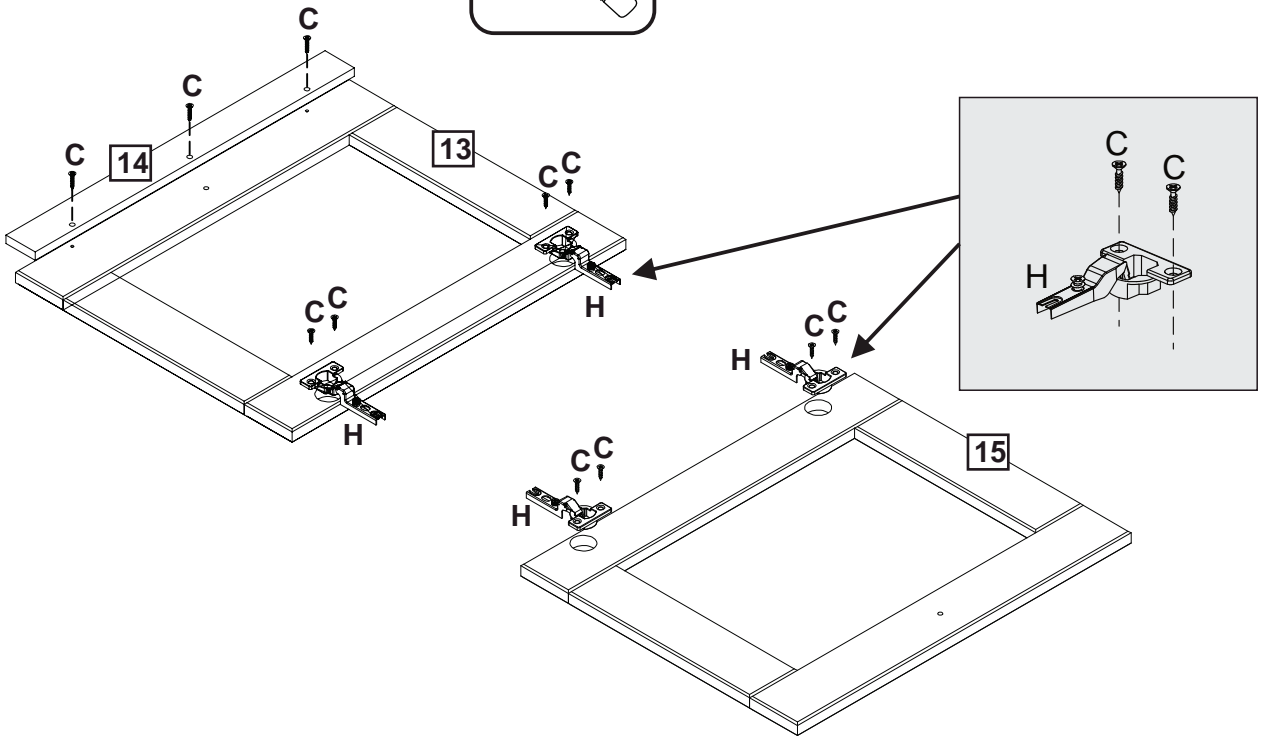
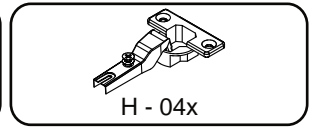
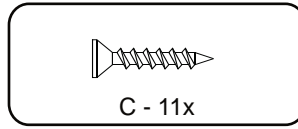
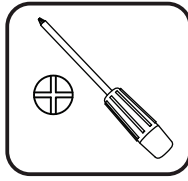

08

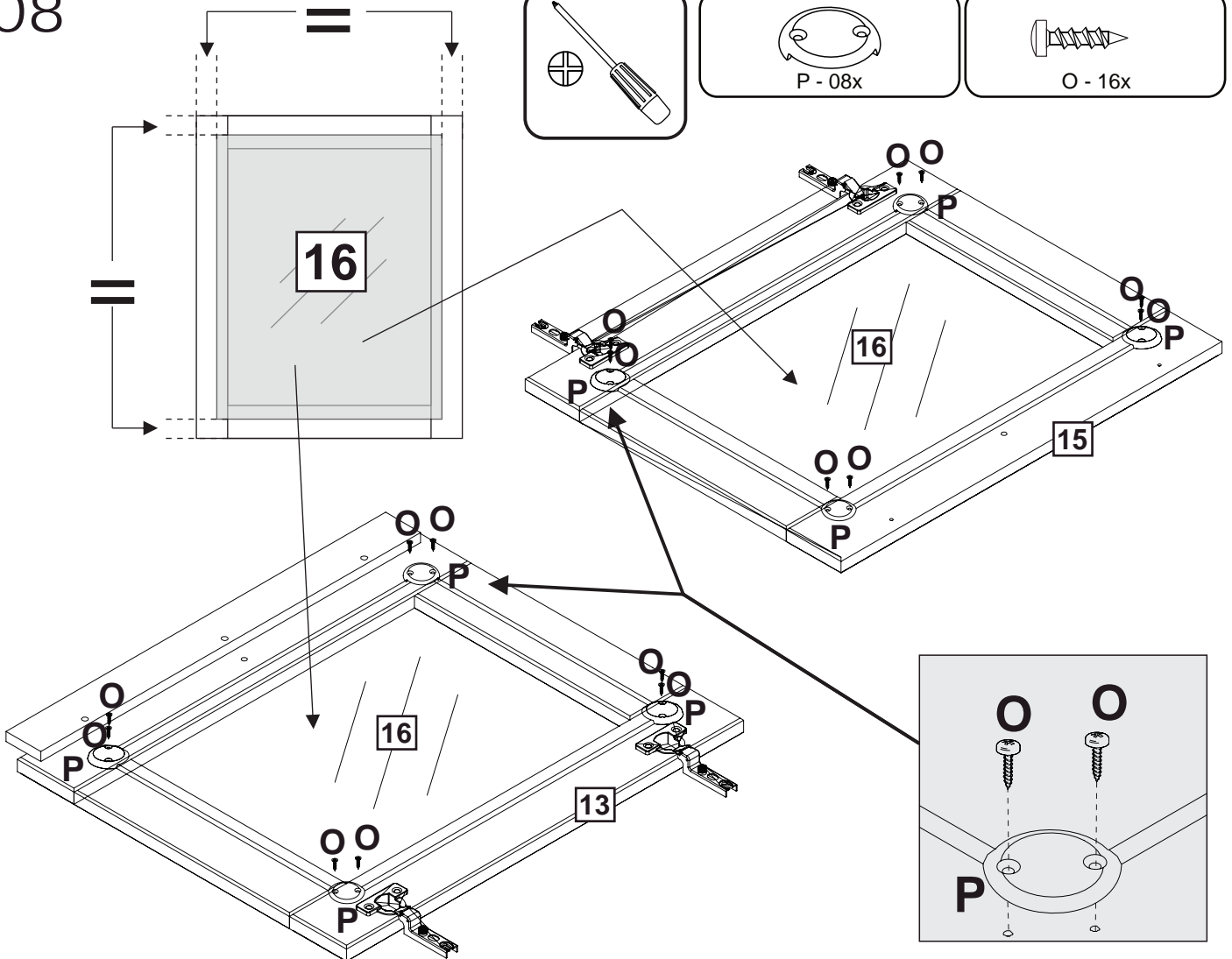
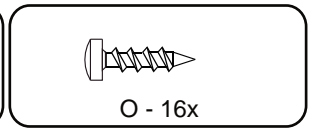
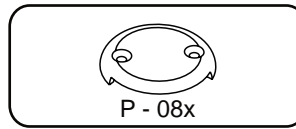
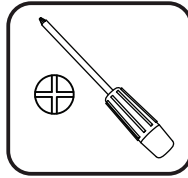

09

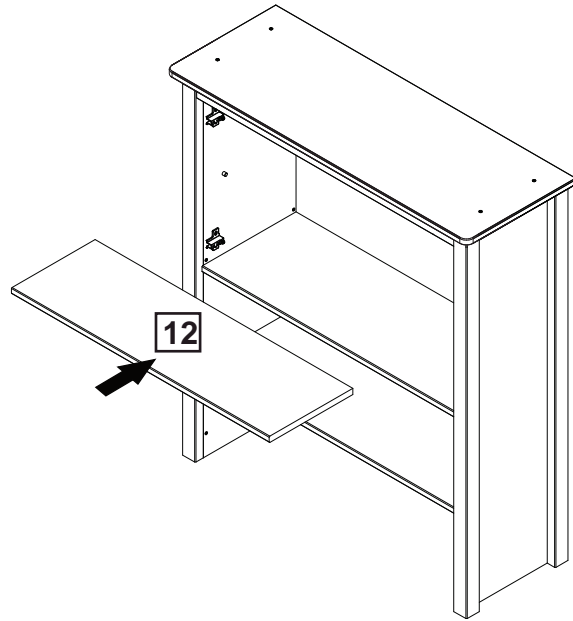

10

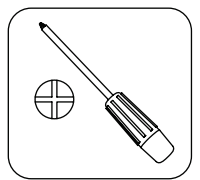
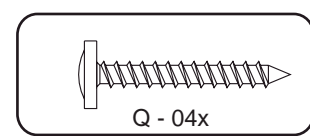
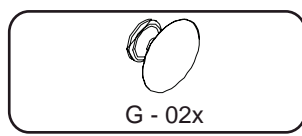
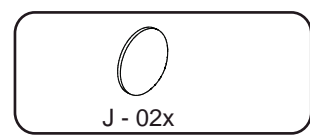
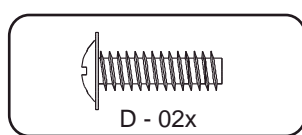
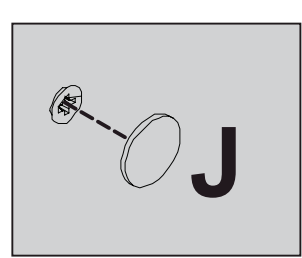
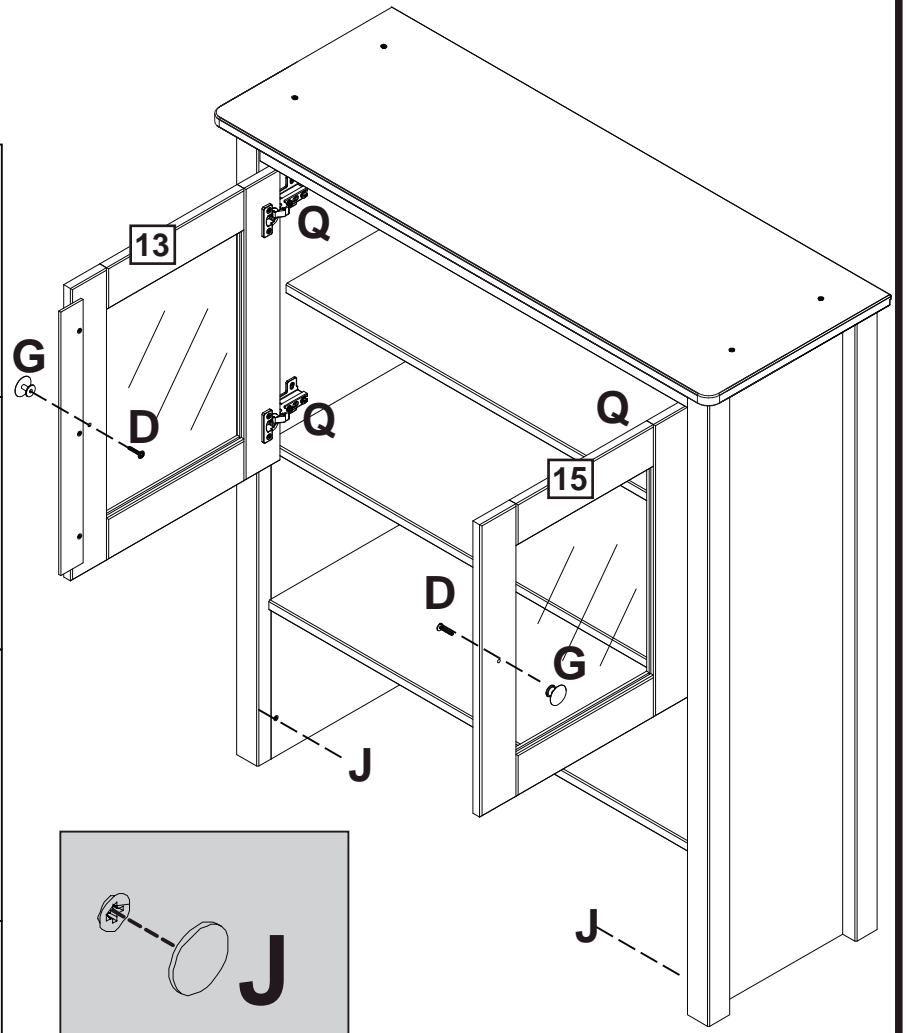
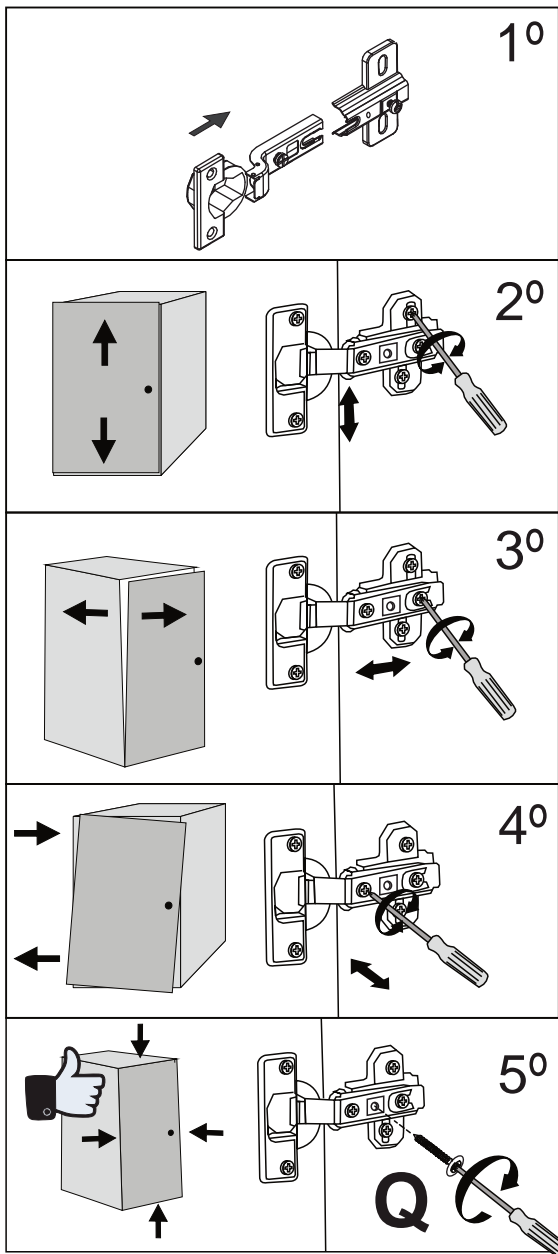

11

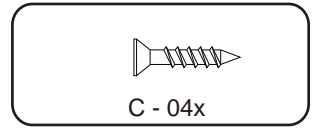
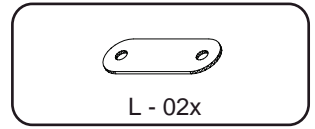
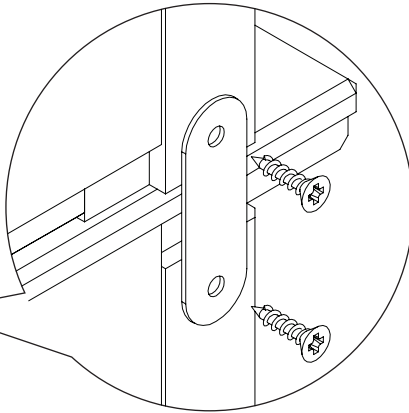
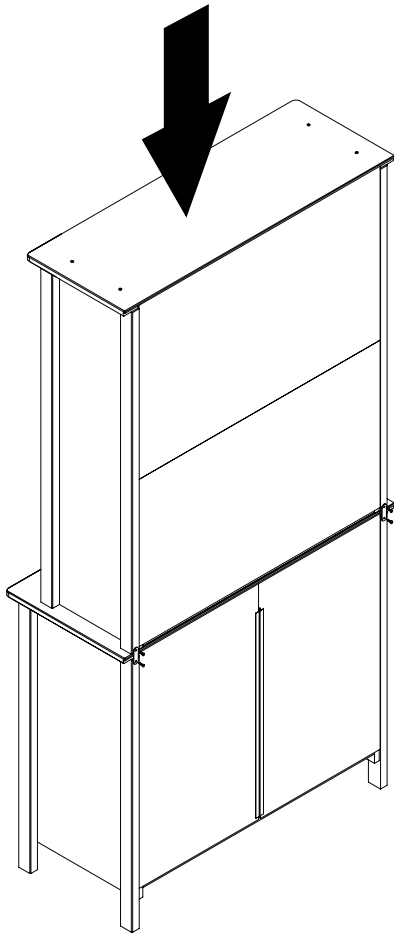

! FIXATION MURALE OBLIGATORIE !
OBLIGATORIO FIJAR A LA PARED !
OBLIGATORY FIX ON THE WALL !

! FIXATION MURALE OBLIGATORIE !
UTILISEZ DES VIS ET DES CHEVILLES ADAPTÉES A VOS MURS !

Il existe une grande diversité de types de murs ou cloisons, c'est la raison pour laquelle nous ne pouvons vous fournir une quincaillerie adaptée à votre mur. Il est nécessaire d'identifier le type de paroi à laquelle vous allez fixer ce produit afin de vous procurer les fixations appropriées. En cas de besoin, adressez vous à un magasin spécialisé pour conseil

! OBLIGATORIO FIJAR A LA PARED !
UTILICE LOS TORNILLOS Y TACOS ADECUADOS PARA SU MURO !

Existe una gran diversidad de muros y paredes, por esta razón no podemos proporcionarle el herraje adecuado para su pared. Primero, es necesario identificar el tipo de pared para luego utilizar el herraje adecuado. En caso de duda, diríjase a una tienda especializada para más información.

! OBLIGATORY FIX ON THE WALL !
USE SCREWS AND PLUGS SUITABLES FOR YOUR WALL !

Due to the wide diversity of wall or partition types, we cannot provide you with suitable attachment fixtures. To determine which attachment fixtures to use, you will need to identify the type of wall to which you will be fixing this product. If you have whatever doubt, please, go to one specialised shop for further information.

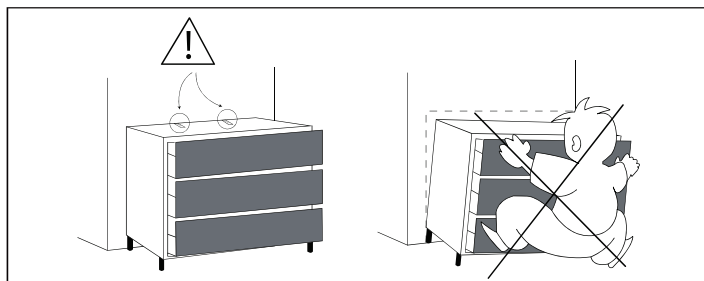

French

IMPORTANT: Pour éviter le basculement accidentel du meuble, la fixation du meuble au mur est obligatoire.

La visserie nécessaire pour la jonction mur/meuble, dépendante de la nature du mur, n'est pas fournie. En cas de doute, consulter un spécialiste

English

IMPORTANT: To avoid the accidental tip-over of the furniture, the fixing of the furniture on the wall is mandatory.

The needed hardware for the junction wall/furniture, depending of the nature of the wall, is not provided. If any doubt, consult a specialist.

Spanish

IMPORTANTE: Para evitar el vuelco accidental de los muebles, es obligatorio fijarlos en la pared.

El tipo de tornillos necesarios para fijar el mueble a la pared, dependen del material de la pared, no se suministran. En caso de duda, consulte a un especialista

Portuguese

IMPORTANTE: Para evitar a queda accidental de móveis, é obrigatorio fixá-los na parede. O tipo de parafusos para a fixação de mobiliário na parede, depende do material de parede e não são fornecidos. Em caso de dúvida, consulte um especialista.

Italian

IMPORTANTE: Per evitare il ribaltamento accidentale del mobile è obbligatorio il fissaggio a muro.

I tasselli necessari per il collegamento mobile\muro, dipendenti dal tipo di muro, non sono provvisti.

Consultare uno specialista in caso di dubbi

Croatian

VAŽNO: Kako bi se izbjeglo slučajno prevrtanje, namještaj je potrebno pričvrstiti na (uza) zid.

Različite vrste zidova zahtijevaju upotrebu različitih vrsta vijaka i tipli. Uvijek koristiti one koji su prikladni za vrstu zidova u domu. Vijci i tiplje prodaju se zasebno.

U slučaju bilo kakvih sumnji, obratite se stručnjaku.

German

WICHTIG : Um ein versehentliches Kippen des Möbels zu vermeiden, ist die Befestigung an der Wand zwingend vorgeschrieben.

Die benötigten Schrauben zur Wandbefestigung, welche von der Beschaffenheit der Mauer abhängen, sind nicht in der Lieferung enthalten. Wenden Sie sich bitte bei Zweifel an einen Spezialisten.

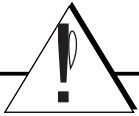
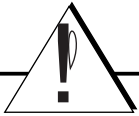

Due to the wide diversity of wall or partition types, we cannot provide you with suitable attachment fixtures. To determine which attachment fixtures to use, you will need to identify the type of wall to which you will be fixing this product. Here are some examples of attachment fixtures recommended for:

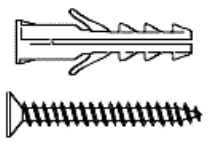
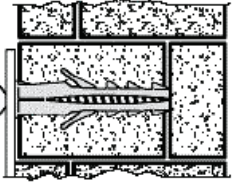
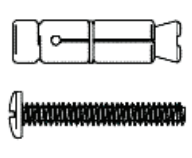
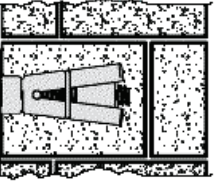
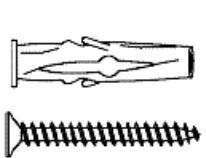
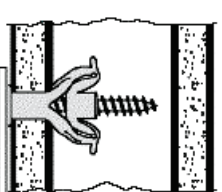
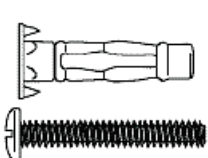
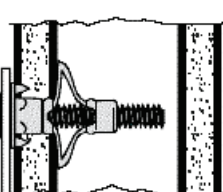
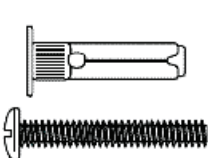
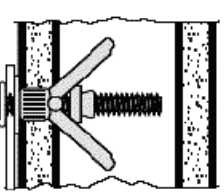

BLIND WALLS		STUDDED WALLS		
<p>"FISCHER" Nylon plug</p>  	<p>Metal Wall plug</p>  	<p>Nylon winged Wall plug</p>  	<p>Metal expansion plug</p>  	<p>"MOLLY" plug</p>  

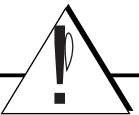

Use a drill bit that is compatible in size with the hardware used and the type of wall.

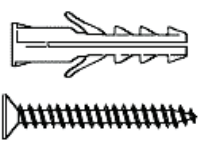
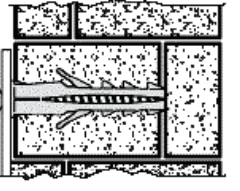
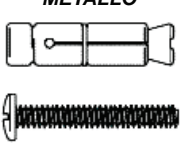
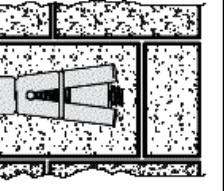
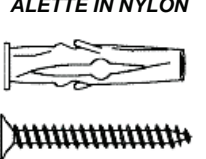
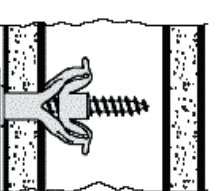
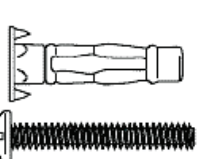
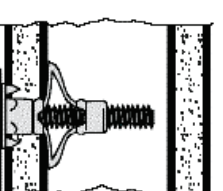

Esiste una gran varietà di tipi di muri o paratie e noi siamo in grado di fornirvi il tipo esatto di fissaggio per ognuno di essi. E' necessario identificare il tipo di parete alla quale intendete fissare questo prodotto in modo da fornirvi i fissaggi più idonei. Ecco qualche esempio di fissaggi consigliati per :

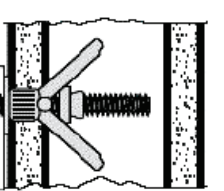
I MURI PIENI		PARATIE CAVE		
<p>TASSELLO NYLON "FISCHER"</p>  	<p>TASSELLO DI ANCORAGGIO IN METALLO</p>  	<p>TASSELLO DI ANCORAGGIO AD ALETTE IN NYLON</p>  	<p>TASSELLO METALLICO AD ESPANSIONE</p>  	<p>TASSELLO "MOLLY"</p>  



Utilizzare una punta di trapano adatta agli utensili utilizzati e al tipo di muro.

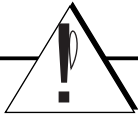

Es gibt eine Vielzahl verschiedener Arten von Mauern oder Zwischenwänden, und aus diesem Grunde können wir Ihnen den genau entsprechenden Befestigungstyp nicht bereitstellen. Zunächst ist es erforderlich, die exakte Bauart der Wand zu ermitteln, an der Sie dieses Produkt anbringen werden, um die für diese Wand geeigneten Befestigungsmittel im Fachhandel erwerben zu können. Nachfolgend einige Beispiele empfohlener Befestigungen für:

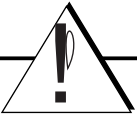

VOLLWÄNDE

**NYLONDÜBEL
„FISCHER“**

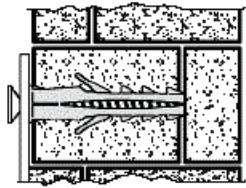
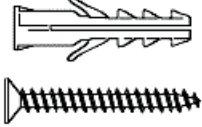

**ANKERDÜBEL
AUS METALL**

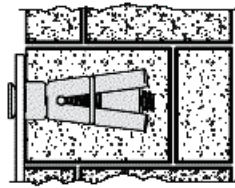
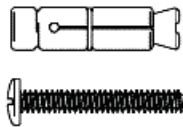

**ANKERDÜBEL MIT
NYLONFLÜGELN**

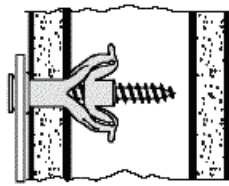
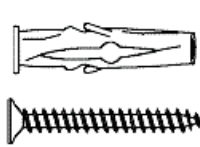

HOHLWÄNDE

**SPREIZDÜBEL FÜR
VERANKERUNG AUS METALL**

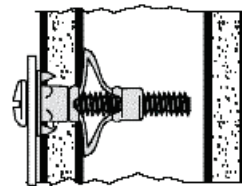
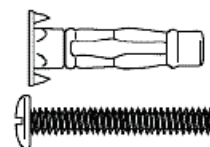

MOLLY-DÜBEL

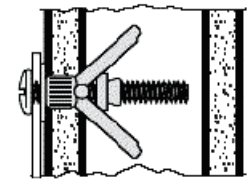
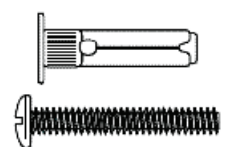

Bitte verwenden Sie eine für die Eisenwaren und den Wandtyp geeignete Bohrergröße.



Il existe une grande diversité de types de murs ou cloisons, c'est la raison pour laquelle nous ne pouvons vous fournir le type exact de fixation. Il est nécessaire d'identifier le type de paroi à laquelle vous allez fixer ce produit afin de vous procurer les fixations appropriées. Voici quelques exemples de fixations conseillées pour:



LES MURS PLEIS

Cheville nylon "FISCHER"

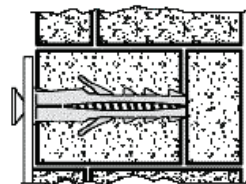
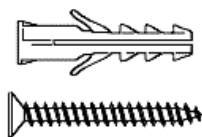

Cheville d'ancrage métal

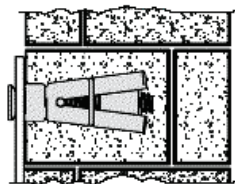
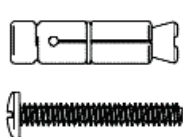

**Cheville d'ancrage
À ailettes en nylon**

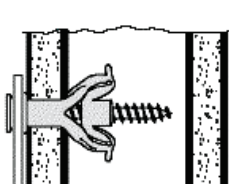
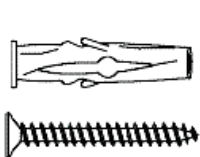

LES CLOISONS CREUSES

**Cheville métallique
À expansion**

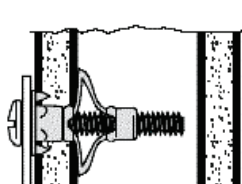
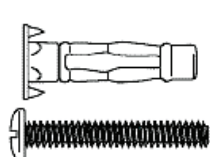

Cheville "MOLLY"

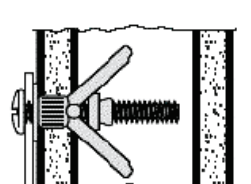
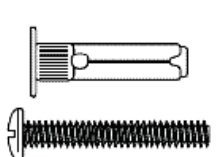

Utiliser une taille de forêt adaptée à la quincaillerie utilisée et au type de mur.

12

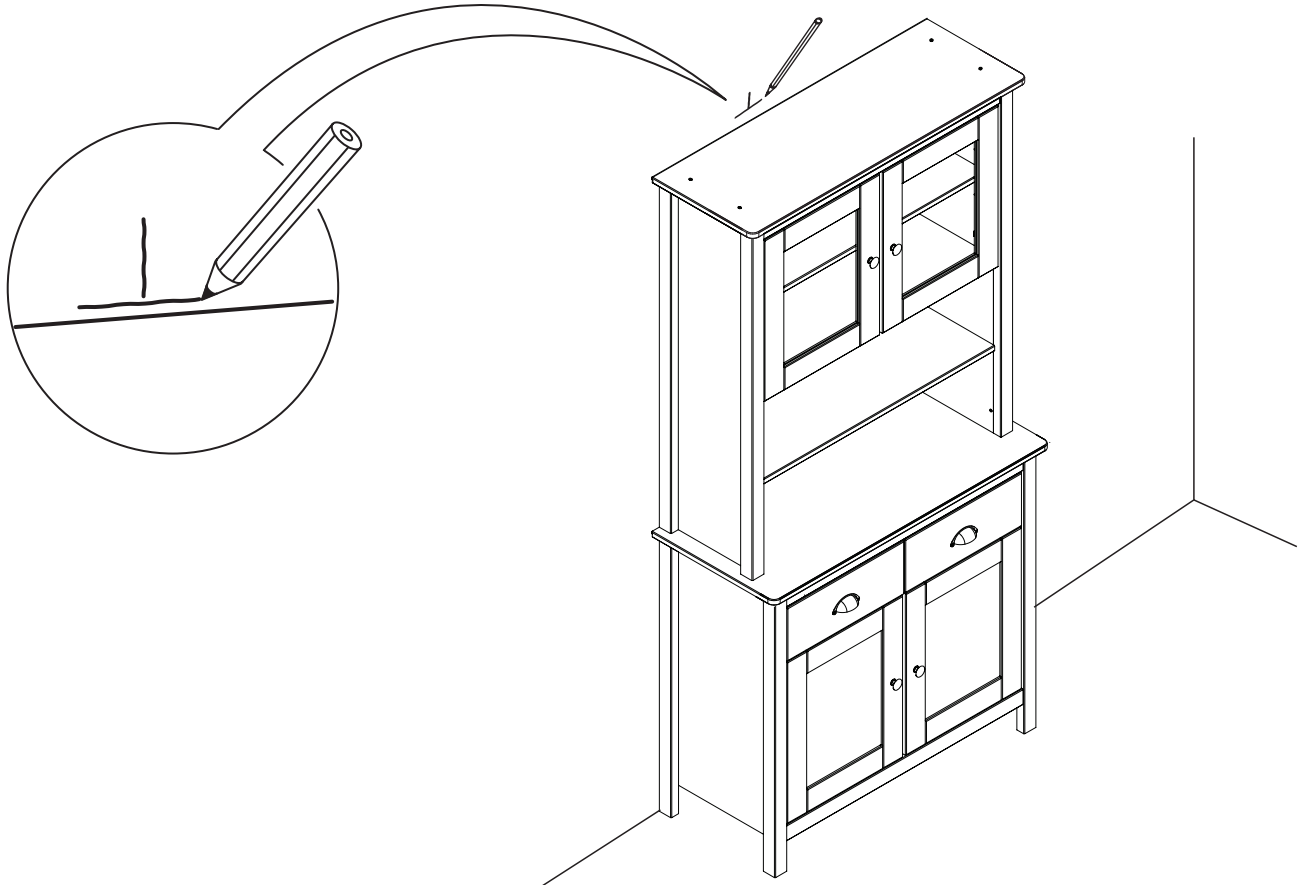

13



FIXATION MURALE OBLIGATORIE
OBLIGATORIO FIJAR A LA PARED
OBLIGATORY FIX ON THE WALL

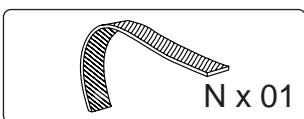
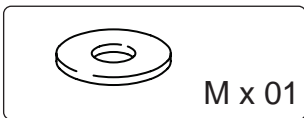
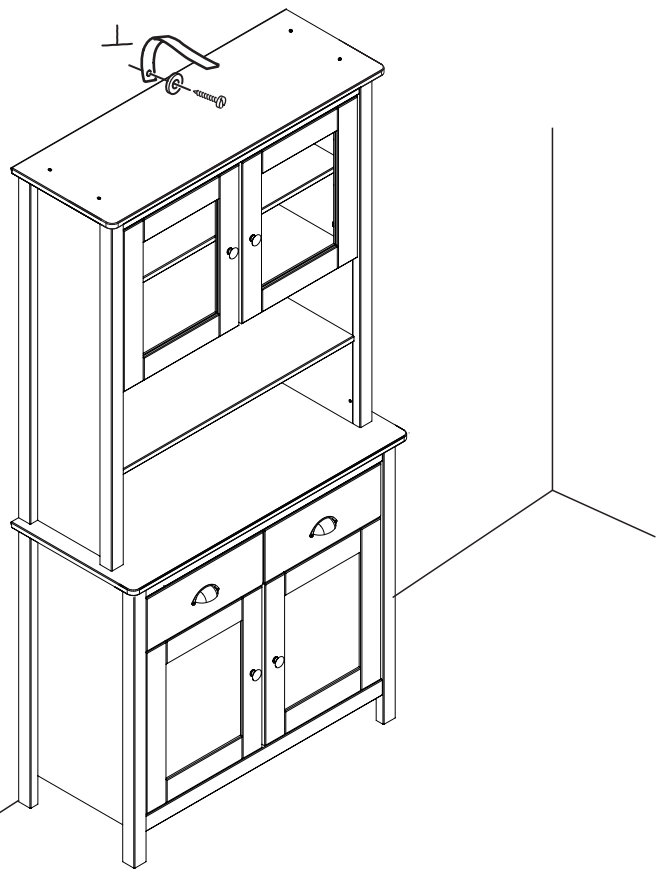
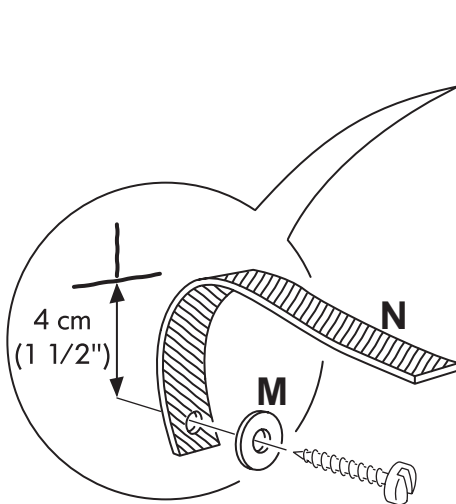

14

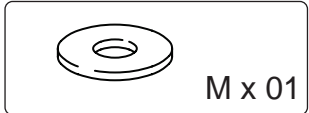
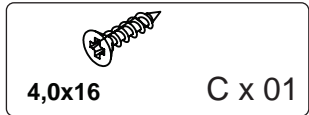
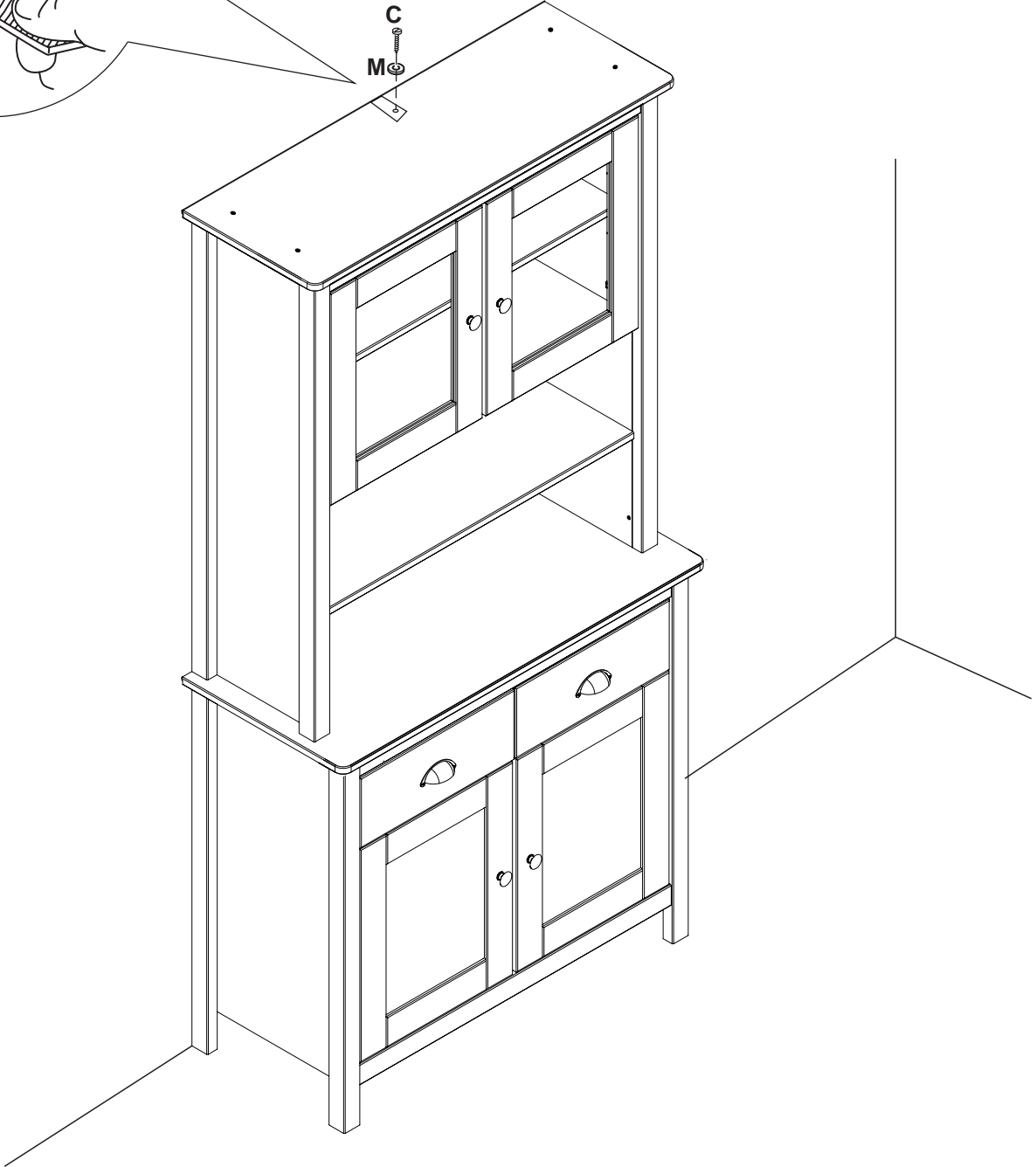
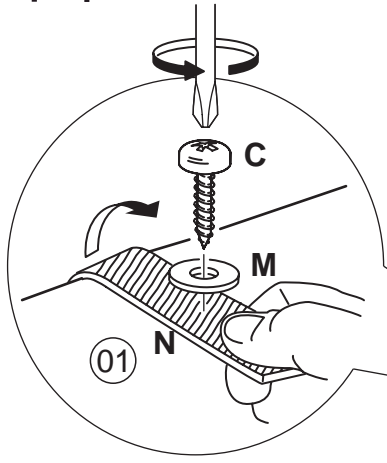

FRENCH: "Les meubles contenant des panneaux à base de bois (panneaux de particules, panneaux de fibres, contreplaqué...) peuvent émettre des substances polluantes dans l'air intérieur. Il est ainsi recommandé, après l'installation du meuble dans son logement, d'aérer fréquemment la pièce concernée pendant au moins quatre semaines afin de réduire son exposition aux polluants émis par le meuble."

SPANISH: Los muebles que contienen paneles a base de madera (Aglomerado, cartón, contrachapado ...) pueden emitir sustancias contaminantes en el aire. Por lo tanto, se recomienda airear frecuentemente los muebles al menos durante cuatro semanas después de su instalación para reducir su exposición a los contaminantes emitidos por los muebles.

ENGLISH: Furniture containing wood-based panels (Particle board, fibreboard, plywood ...) could emit pollutants on the air. Therefore, it is advisable to ventilate the furniture at least during four weeks after its assembly in order to reduce the exposure to the pollutants released by the furniture.

FRANCAIS - SUISSE

CONSEILS DE MONTAGE :

- 1 > BIEN ETUDIER LA NOTICE DE MONTAGE.
- 2 > REPEREZ LES PIECES CONSTITUANT VOTRE MEUBLE.
- 3 > REGROUPEZ ET CONTROLEZ LA QUINCAILLERIE.
- 4 > MUNISSEZ-VOUS DE L'OUTILLAGE NECESSAIRE.
- 5 > AMENAGEZ-VOUS UNE ZONE DE MONTAGE.
- 6 > PROCEDEZ AU MONTAGE.



**NE JAMAIS FORCER LES ASSEMBLAGES.
RESSERREZ LES VIS APRES QUELQUES TEMPS D'USAGE.
GARDER VOTRE NOTICE DE MONTAGE, SI UNE PIECE
VENAIT A MANQUER, ELLE SERAIT LE PLUS CLAIR
MOYEN DE COMMUNIQUER AVEC VOTRE MAGASIN.**

CONSEILS D'ENTRETIEN :

- 1 > DÉPOUSSIÉREZ SOIGNEUSEMENT.
- 2 > UTILISEZ UN CHIFFON SEC.



**- NE JAMAIS UTILISER
DE PRODUITS ABRASIFS:
POUDRE, LAINE D'ACIER, SOLVANTS.
- NE PAS MOUILLER**

	PAPIER DECOR	SURFACES STRATIFIÉES	SURFACES LAQUÉES	BOIS VERNIS	TEXTILE CUIR
EAU SAVONNEUSE (SAVON NEUTRE)	○	○	○	○	○
EAU ADDITIO NÉE		○	○		
ENTRETIEN SPÉCIFIQUE FABRICANT					○

DEUTSCH - SCHWEIZ

MONTAGE ANLEITUNG:

- 1 > DIE MONTAGEANLEITUNG SORGFÄLTIG DURCHLESEN.
- 2 > DIE EINZELTEILE DES MÖBELSTÜCKS ERMITTELN.
- 3 > DIE BESCHLÄGE ZUSAMMENLEGEN UND PRÜFEN.
- 4 > DAS NOTWENDIGE WERKZEUG ZURECHTLEGEN.
- 5 > EINEN MONTAGEBEREICH FREIMACHEN.
- 6 > DAS MÖBELSTÜCK ZUSAMMENBAUEN.



**NIEMALS DIE VERBINDUNGEN ZU STARK ANZIEHEN.
DIE SCHRAUBEN NACH EINIGER ZEIT DES GEBRAUCHS
ERNEUT FESTZIEHEN. DIE MONTAGEANLEITUNG
GUT AUFBEWAHREN: SOLLTE EIN TEIL FEHLEN, IST SIE DAS
BESTE VERSTÄNDIGUNGSMITTEL MIT IHREM GESCHÄFT.**

PFLEGEHINWEISE :

- 1 > SORGFÄLTIG ENTSTAUBEN.
- 2 > VERWENDEN SIE EIN TROCKENES TUCH.



**- BENUTZEN SIE KEINE
SCHEUERMITTEL WIE PULVER,
STAHLWOLLE, LÖSUNGSMITTEL.
- KEIN WASSER VERWENDEN.**

	DEKORPAPIER	OBERFLÄCHE LAMINAT	OBERFLÄCHE LACK	LACKIERTEM HOLZ	TEXUL LEDER
SEIFENLAUGE (NEUTRALSEIFE)	○	○	○	○	○
WASSER MIT HAUSHALTSRFINIGER		○	○		
PRODUZENT SPEZIFISCHER UNTERHALT					○

ITALIANO - SVIZZERA

CONSIGLI DI MONTAGGIO

- 1 > STUDIARE BENE LE ISTRUZIONI DI MONTAGGIO.
- 2 > PRENDERE CONOSCENZA DEI PEZZI CHE COSTITUISCONO IL MOBILE.
- 3 > RAGGRUPPARE E CONTROLLARE LA FERRAMENTA.
- 4 > MUNIRSI DEGLI UTENSILI NECESSARI.
- 5 > PREPARARE UNA ZONA DI MONTAGGIO.
- 6 > PROCEDERE AL MONTAGGIO.



**NON FORZARE MAI GLI ASSEMBLAGGI
RISTRINGERE LE VITI DOPO UN PERIODO D'USO
CONSERVARE QUESTE ISTRUZIONI DI MONTAGGIO,
SE UN PEZZO VENISSE A MANCARE SAREBBE IL MIGLIORE
MEZZO DI COMUNICAZIONE CON IL RIVENDITORE**

CONSIGLI PER LA MANUTENZIONE :

- 1 > SPOLVERATE ACCURATAMENLE.
- 2 > USARE UN PANNINO ASCIUTTO.



**- NON UTILIZZARE MAI PRODOTTI
ABRASIVI: POLVERE,
LANA DI ACCIAIO, SOLVENTI.
- NON BAGNARE.**

	CARTA	SUPERFICIE STRATIFICATE	SUPERFICIE LACCATE	LACCATE EGNO VERNICIATO	TESSILE CUOIO
ACQUA CON SAPONE (SAPONE NEUTRO)	○	○	○	○	○
ACQUA CON DETERSIVO SAN MARC		○	○		
MANUTENZIONE SPECIFICA PRODUTTORE					○

PORTUGUÊS

CONSELHOS DE MONTAGEM:

- 1 > ESTUDE BEM AS INSTRUÇÕES DE MONTAGEM.
- 2 > REUNA AS PEÇAS QUE CONSTITUEM O SEU MÓVEL.
- 3 > REAGRUPE AS FERRAGENS.
- 4 > EQUIPE-SE COM AS FERRAMENTAS NECESSÁRIAS.
- 5 > PREPARE UMA ÁREA PARA A MONTAGEM.
- 6 > INICIE A MONTAGEM.



NUNCA FORÇAR OS ENCAIXES.
REAPERTAR OS PARAFUSOS APÓS UM TEMPO DE UTILIZAÇÃO.
GUARDAR AS INSTRUÇÕES DE MONTAGEM.
CASO FALTE ALGUMA PEÇA, O MAIS ACONSELHÁVEL É CONTATAR O REVENDEDOR.

CONSELHOS PARA A MANUTENÇÃO :

- 1 > ELIMINAR BEM O PÓ.
- 2 > USAR PANO SECO.



- NUNCA UTILIZAR PRODUTOS ABRASIVOS: SAPONÁCEOS, LÃ DE AÇO, SOLVENTES.
- NÃO MOLHAR .

	ACABAMENTO IMITAÇÃO	SUPERFÍCIES ESTRATIFICADAS	SUPERFÍCIES LACADAS	MADEIRA ENVERNIZADA	TEXTEIS PELES
ÁGUA COM SABÃO (SABÃO NEUTRO)	○	○	○	○	○
ÁGUA COM DETERGENTE		○	○		
INSTRUÇÕES ESPECÍFICAS DO FABRICANTE					○

ESPAÑOL

CONSEJOS PARA EL MONTAJE:

- 1 > ESTUDIE ATENTAMENTE EL MANUAL DE MONTAJE.
- 2 > LOCALICE LAS PIEZAS QUE CONSTITUYEN SU MUEBLE.
- 3 > REUNA Y CONTROLE LOS TORNILLOS.
- 4 > EQUIPE-SE DE LAS HERRAMIENTAS NECESARIAS.
- 5 > PREPARE UNA ZONA DE MONTAJE.
- 6 > REALICE EL MONTAJE.



NO FUERCE NUNCA EN LAS UNIONES. APRIETE LOS TORNILLOS DESPUES DE CIERTO TIEMPO DE UTILIZACION
CONSERVE SU MANUAL DE MONTAJE,
SI FALTARA UNA PIEZA, SERIA LA MANERA MAS FACIL DE COMUNICAR CON LA TIENDA.

CONSEJOS PARA EL MANTENIMIENTO:

- 1 > DESPOLVOREAR CULDADOSAMENTE.
- 2 > UTILICE UN PAÑO SECO.



- NO USE NUNCA PRODUCTOS ABRASIVOS TALES COMO: POLVO DE LIMPIAR, LANA DE ACERO, SOLVENTES.
- NO MOJAR.

	PAPEL DE DECORACION	SUPERFICIE ESTRATIFICADAS	SUPERFICIE MAQUEADAS	MADERA BARNIZADA	TEXULL CUERO
AGUA Y JABON (JABON NEUTRO)	○	○	○	○	○
AGUA COM DETERGENTE		○	○		
MANTENIMIENTO ESPECIFICO DEL FABRICANTE					○

HRVATSKA

UPUTE ZA MONTAŽU:

- 1 > PAŽLJIVO PROČITAJTE UPUTE ZA MONTAŽU.
- 2 > PRIPREMITE SVE DIJELOVE NAMJEŠTAJA.
- 3 > PRIKUPITE I PROVJERITE OKOVE ZA MONTAŽU.
- 4 > PRIPREMITE POTREBAN ALAT .
- 5 > PRIPREMITE PROSTOR ZA MONTAŽU.
- 6 > POČNITE MONTIRATI.



NEMOJTE UPOTREBLJAVATI SILU PRILIKOM SKLAPANJA
NAKON NEKOG VREMENA PONOVRNO PRITEGNIJE VIJKE
ČUVAJTE UPUTE ZA MONTAŽU
U SLUČAJU NEDOSTATKA NEKOG DIJELA NAJBOLJE ĆE BITI DA DA KONTAKIRATE PRODAJNO MJESTO.

UPUTE ZA ODRŽAVANJE :

- 1 > PAŽLJIVO OBRISATI PRAŠINU.
- 2 > KORISTITE SUHU KRPU.



- ZABRANJENA JE UPOTREBA KEMIKALIJA ILI BILO KAKVIH POMOĆNIH SREDSTAVA ZA RIBANJE JAKIH SREDSTAV ZA ČIŠĆENJE ILI ČELIČNE VUNE
-NE MOKRA.

	PAPIR	LAMINAT	LAK	DRVO	TEKSTIL/ KOŽA
OTPINA SAPUNA	○	○	○	○	○
OTPINA DETERDŽENTA		○	○		
NAMJENSKA SREDSTVA					○

TÜRÇE

MONTAJ TALIMATLARI:

- 1 > MONTAJ TANITIM YAZISINI DIKKATLICE OKUYUNUZ .
- 2 > MOBİLİYANIZI OLUŞTURAN PARÇALARI İŞARETLEYİNİZ.
- 3 > HIRDAVATLA İLGİLİ PARÇALARI BİR ARAYA TOPLAYIP; KONTROL EDİNİZ.
- 4 > GEREKEN ARAÇ VE GEREÇİ TEDARİK EDİNİZ.
- 5 > (KENDİNİZE) BİR MONTAJ ALANI EDİNİNİZ.
- 6 > MONTE ETMEYE BAŞLAYINIZ.



**MONTAJLARI ZORLAMAYINIZ.
BİRKAÇ KULLANIMDAN SONRA VIDALARI SIKIŞTIRINIZ.
BİR PARÇANIN KAYBOLMASI DURUMUNDA MAGAZANIZLADAHA
KOLAY İLETİŞİME GEÇEBİLMEZ İÇİN MONTAJ KULLANIM
TALIMATINIZI SAKLAYINIZ.**

BAKIM TALIMATLARI:

- 1 > TOZUNU DIKKATLICE ALINIZ.
- 2 > YUMUŞAK BİR BEZİ TEMİZ SU VE AZ MİKTARDA SABUNLA(DETERJAN) NEMLENDİRİNİZ.



**ASLA AŞINDIRICI ÜRÜNLER
KULLANMAYINIZ : ÇELİK YÜNÜ,
SOLVENT...
BOL SUYLA YIKAMAYINIZ.**

	SÜS KAGIDI	KATMAN YÜZEY	LAKE YÜZEY	CILALI TAHTA	TEKSTİL DERİ
SABUNLU SU (NOTR SABUN)	○	○	○	○	○
DETERJAN KATILMIŞ SU		○	○		
ÜRETİCİYE ÖZGÜ BAKIM					○

ENGLISH

ASSEMBLY ADVICE :

- 1 > CAREFULLY READ THE ASSEMBLY INSTRUCTION.
- 2 > IDENTIFY THE COMPONENTS OF THE FURNITURE.
- 3 > GROUP AND CHECK THE HARDWARE.
- 4 > USE THE REQUIRED TOOLS.
- 5 > CREATE AN ASSEMBLY ZONE.
- 6 > MAKE THE ASSEMBLY.



**NEVER FORCE THE CONNECTIONS.
RE-TIGHTEN THE SCREWS AFTER FEW DAYS.
PLEASE RETAIN THE AI LEAFLET FOR FUTURE REFERENCE,
THE AI CONTAINS INFORMATION WHEN CLAIMING
FOR MISSING PARTS.**

CLEANING ADVICE:

- 1 > CAREFULLY REMOVE THE DUST.
- 2 > USE A SOFT, CLEAN DAMP CLOTH WITH SOAPY WATER.



**NEVER USE ABRASIVE PRODUCTS
OR SOLVENTS.
DO NOT APPLY EXCESSIVE PRESSURE
WHEN USING THE DAMP CLOTH.**

	PAPER DECOR	LAMINATED SURFACES	LACQUERED SURFACE	VARNISHED WOOD	LEATHER TEXTILE
SOAPY WATER (NEUTRAL SOAP)	○	○	○	○	○
WATER WITH DETERGENT		○	○		
SPECIFIC SUPPLIER CLEANING					○



**LE TRI
+ FACILE**



FR

Donnez ou recyclez
vos meubles.



ou



ou



<https://quefairedemesdechets.fr>