

# Dam Chair

White wash   Black   Marine Blue   Olivia Green

Teulat

NOTICE DE MONTAGE  
INSTRUCCIONES DE MONTAJE / ASSEMBLY INSTRUCTIONS

Teulat

 x1  
2 PCS/1CTN

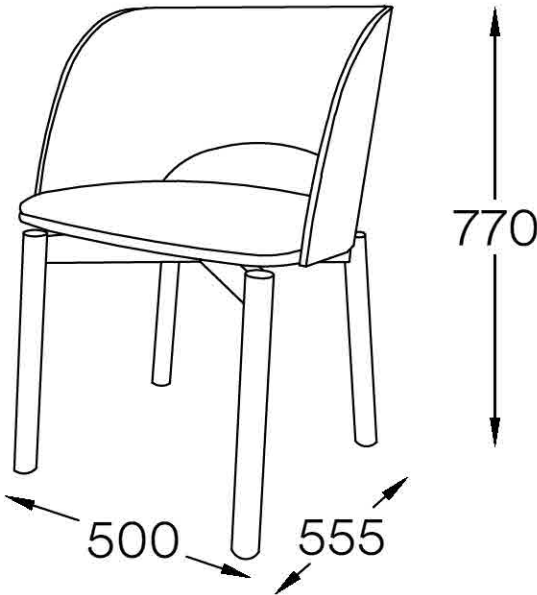

13647\_TE  
13666\_TE  
13667\_TE  
13668\_TE

SILLA DAM  
CHAISE DAM  
CHAIR DAM

8435178375490  
8435178375032  
8435178376701  
8435178376695

*AVANT DE COMMENCER, SE  
REPORTER AUX CONSEILS  
DE MONTAGE EN ANNEXE*

**BEFORE STARTING, REFER  
TO THE ASSEMBLING ADVICE  
IN ANNEX**

*VOR DER MONTAGE,  
BEILIEGENDE ANWEISUNGEN  
BEFOLGEN.*

*PRIMA DI COMINCIARE  
LEGGETE LE ISTRUZIONI DI  
MONTAGGIO*

*ANTES DE COMENÇAR, ADIAR  
SE AOS CONSELHOS DE  
MONTAGEM EM ANEXO*

**ANTES DE EMPEZAR  
CONSULTE LOS CONSEJOS  
PARA EL MONTAJE**

*PRIJE MONTIRANJA OVOG  
ARTIKLA, MOLIMO PROU  
ČITE PRILO ŽENE UPUTE  
ZA MONTAŽU*

**BASLAMADAN ÖNCE,  
EKTEKI MONTAJ TALIMATLARINI  
İNCELEYİNİZ**

Tamaño de la caja Dimensions colis Carton dimensions	Peso bruto Poids brut Gross weight	Peso neto Poids net Net weight
84.6 x 53.6 x 51.2 (CM)	19.50 (KG)	15.50 (KG)

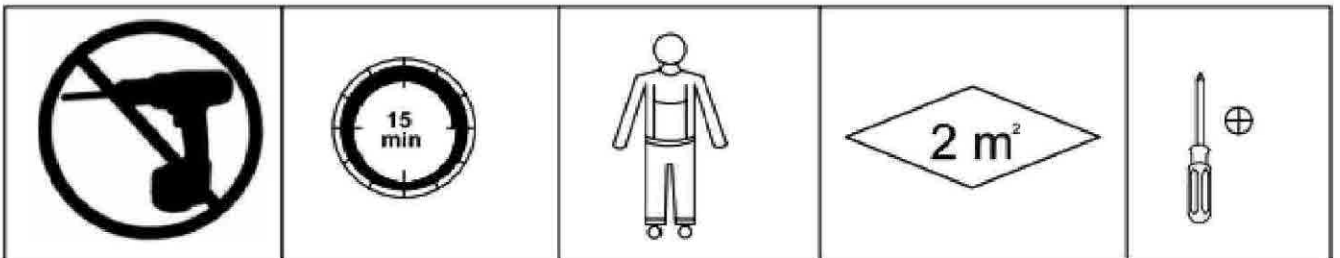

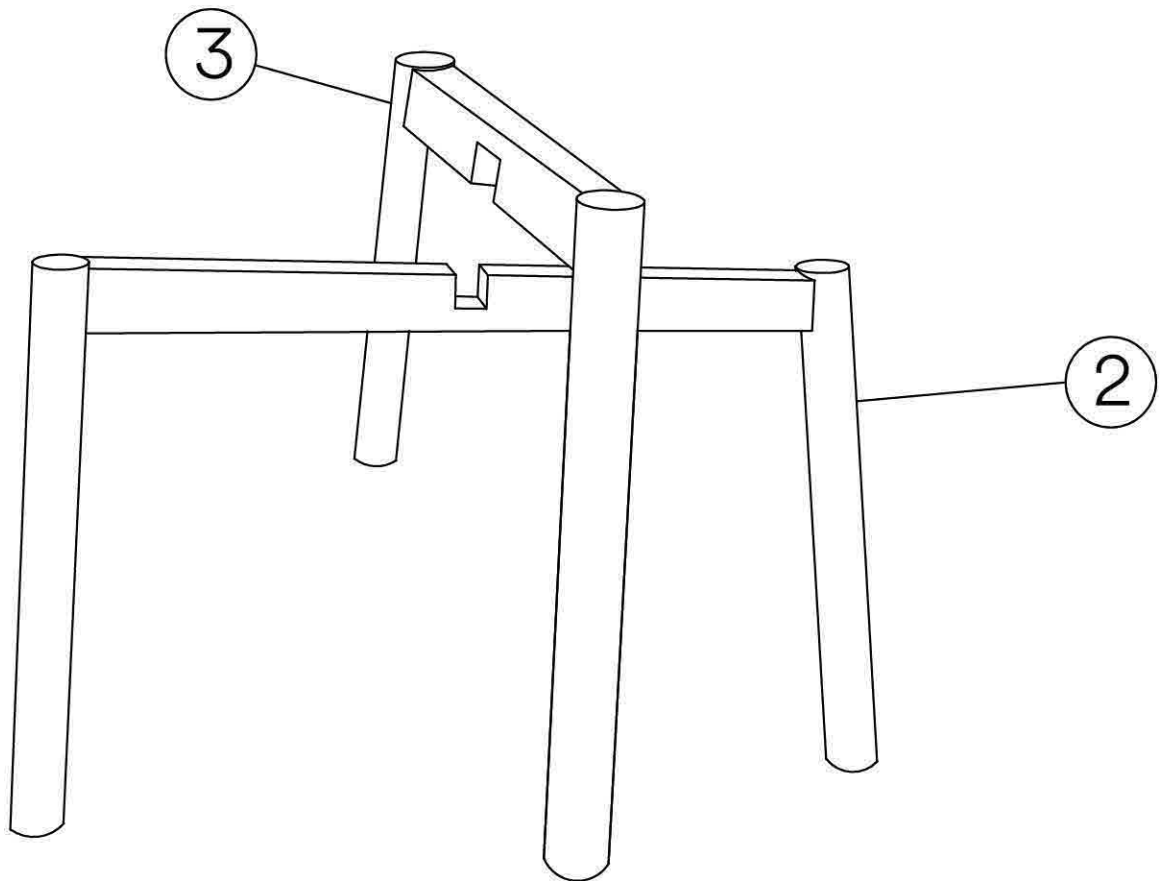
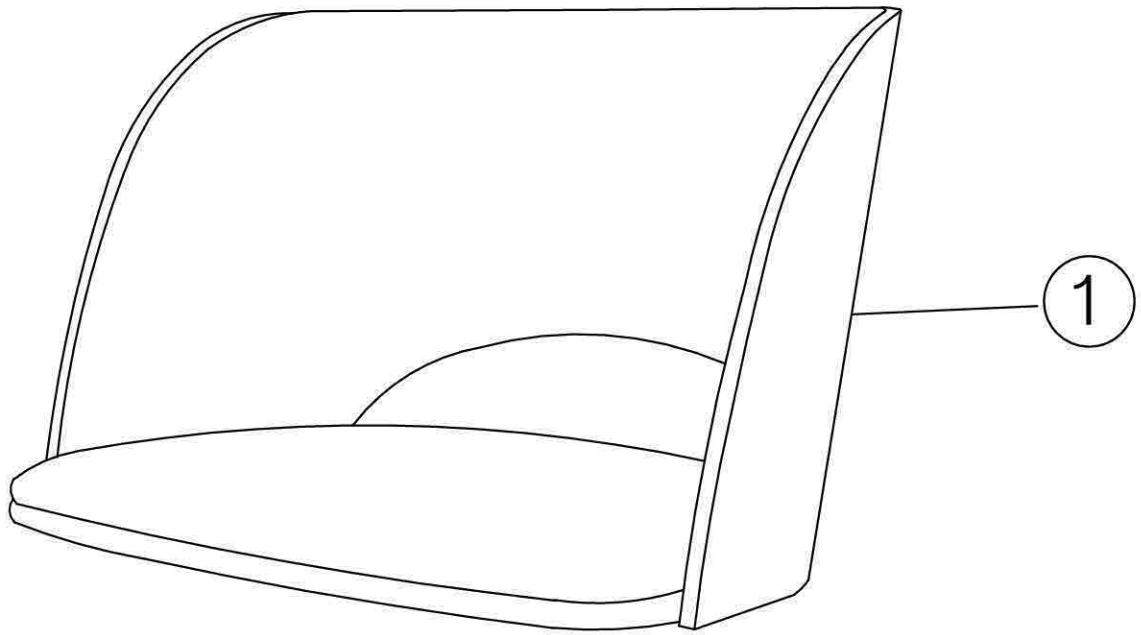



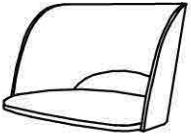
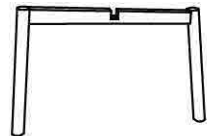
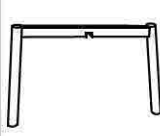

**LISTADO DE PIEZAS  
COMPOSANTS  
PARTS LIST**

<b>1</b>		1 PC	<b>2</b>		1 PC	<b>3</b>		1 PC

**HERRAJES  
QUINCALLERIE  
HARDWARE**

<b>A</b>		1 PC	<b>C</b>	 5/16" (RB)	8 PCS	<b>D</b>	 6*13MM (RB)	8 PCS
<b>F</b>		4 PCS						

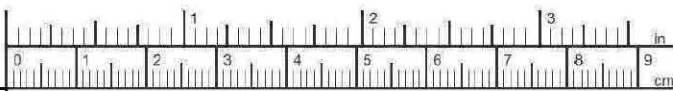

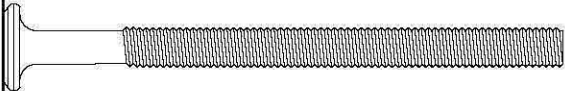
**B** x8   
M6x80MM (RB)

**E** x1   
M5x32MM (BLK)

# STEP 1/ ETAPE 1

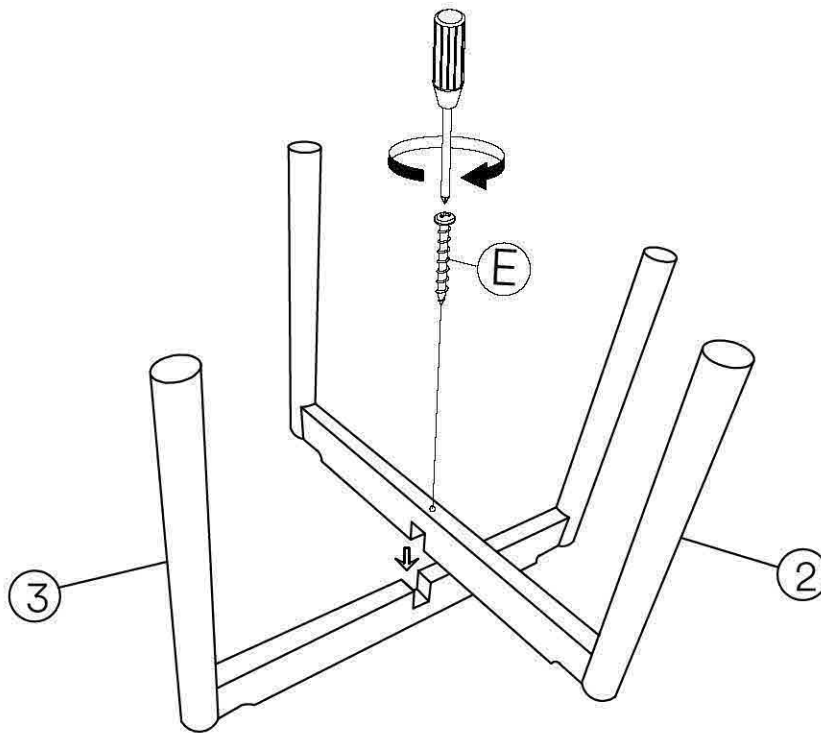





E		1 PC
---	---	------

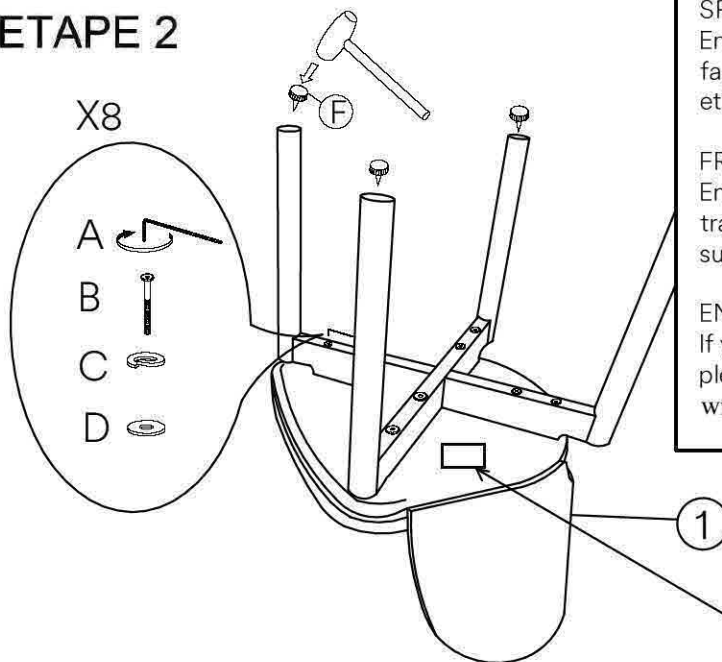





# STEP 2/ ETAPE 2



X8

- A 
- B 
- C 
- D 

A		1 PC
B		8 PCS
C		8 PCS
D		8 PCS
F		4 PCS



**SPANISH :**

En caso de reclamación, por favor, facilitar la información escrita en la etiqueta.

**FRENCH :**

En cas de réclamation, merci de transmettre les informations contrnues sur l' étiquette fixée sur le produit.

**ENGLISH :**

If you may have whatever complaint, please, let us know the information written on the label.

PI : XXX  
Model: YYY  
XXX

PRODUIT MONTÉ

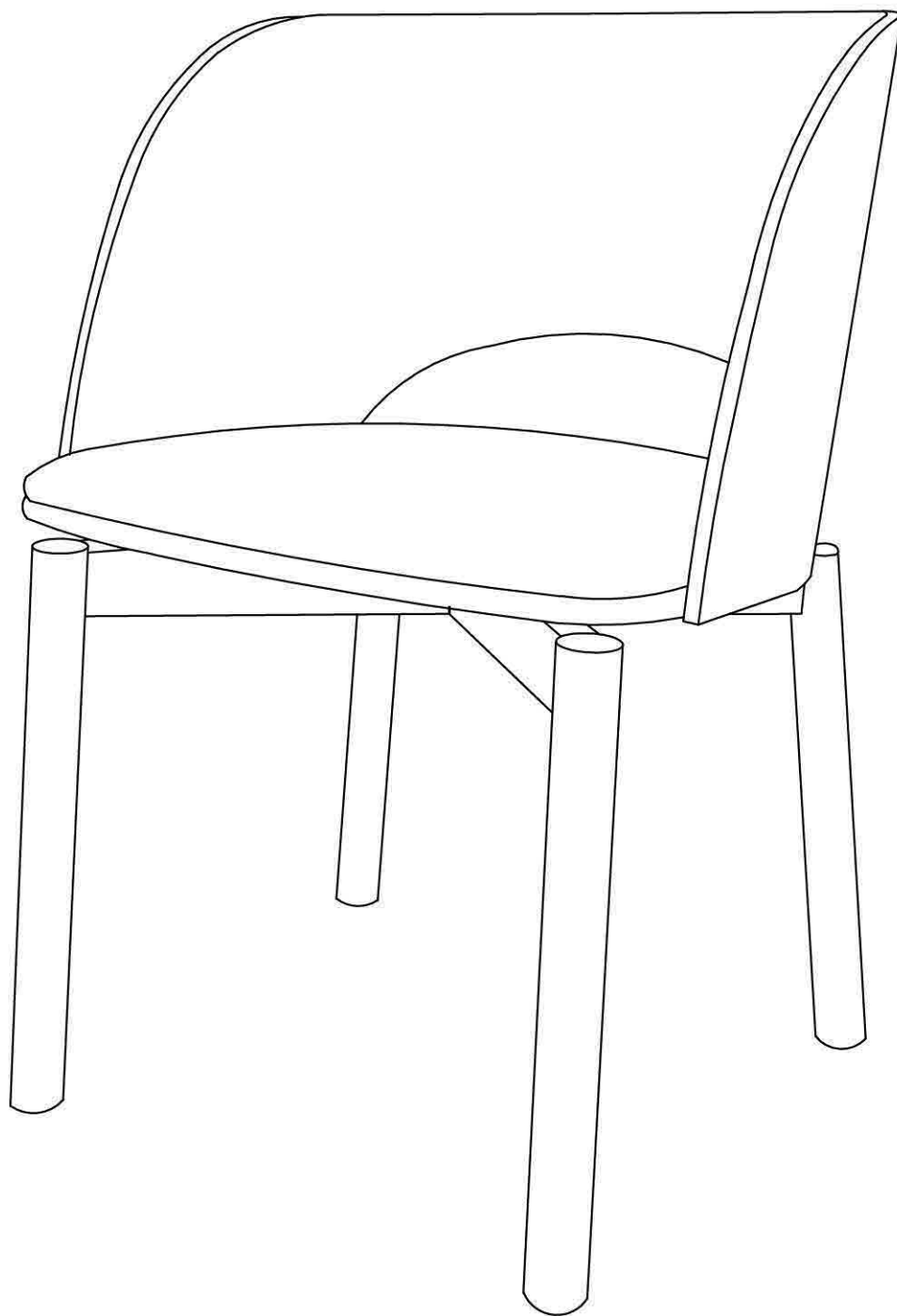

## FRANCAIS - SUISSE

### CONSEILS DE MONTAGE :

- 1 > BIEN ETUDIER LA NOTICE DE MONTAGE.
- 2 > REPEREZ LES PIÈCES CONSTITUANT VOTRE MEUBLE.
- 3 > REGROUPEZ ET CONTROLEZ LA QUINCAILLERIE.
- 4 > MUNISSEZ-VOUS DE L'OUTILLAGE NECESSAIRE.
- 5 > AMENAGEZ-VOUS UNE ZONE DE MONTAGE.
- 6 > PROCEDEZ AU MONTAGE.



**NE JAMAIS FORCER LES ASSEMBLAGES. RESERRER LES VIS APRES QUELQUES TEMPS D'USAGE. GARDER VOTRE NOTICE DE MONTAGE, SI UNE PIÈCE VENAIT A MANQUER, ELLE SERAIT LE PLUS CLAIR MOYEN DE COMMUNIQUER AVEC VOTRE MAGASIN.**

### CONSEILS D'ENTRETIEN :

- 1 > DÉPOUSSIÉREZ SOIGNEUSEMENT.
- 2 > UTILISEZ UN CHIFFON SEC.



**- NE JAMAIS UTILISER DE PRODUITS ABRASIFS: POUDRE, LAINE D'ACIER, SOLVANTS. - NE PAS MOUILLER**

	PAPIER DECOR	SURFACES STRATIFIÉES	SURFACES LAQUÉES	BOIS VERNIS	TEXTILE CUIR
EAU SAVONNEUSE (SAVON NEUTRE)	○	○	○	○	○
EAU ADDITIO NÉE		○	○		
ENTRETIEN SPÉCIFIQUE FABRICANT					○

## DEUTSCH - SCHWEIZ

### MONTAGE ANLEITUNG:

- 1 > DIE MONTAGEANLEITUNG SORGFÄLTIG DURCHLESEN.
- 2 > DIE EINZELTEILE DES MÖBELSTÜCKS ERMITTELN.
- 3 > DIE BESCHLÄGE ZUSAMMENLEGEN UND PRÜFEN.
- 4 > DAS NOTWENDIGE WERKZEUG ZURECHTLEGEN.
- 5 > EINEN MONTAGEBEREICH FREIMACHEN.
- 6 > DAS MÖBELSTÜCK ZUSAMMENBAUEN.



**NIEMALS DIE VERBINDUNGEN ZU STARK ANZIEHEN. DIE SCHRAUBEN NACH EINIGER ZEIT DES GEBRAUCHS ERNEUT FESTZIEHEN. DIE MONTAGEANLEITUNG GUT AUFBEWAHREN: SOLLTE EIN TEIL FEHLEN, IST SIE DAS BESTE VERSTÄNDIGUNGSMITTEL MIT IHREM GESCHÄFT.**

### PFLEGEHINWEISE :

- 1 > SORGFÄLTIG ENTSTAUBEN.
- 2 > VERWENDEN SIE EIN TROCKENES TUCH.



**- BENUTZEN SIE KEINE SCHEUERMITTEL WIE PULVER, STAHLWOLLE, LÖSUNGSMITTEL. - KEIN WASSER VERWENDEN.**

	DEKORPAPIER	OBERFLÄCHE LAMINAT	OBERFLÄCHE LACK	LACKIERTEM HOLZ	TEXTIL LEDER
SEIFENLAUGE (NEUTRALSEIFE)	○	○	○	○	○
WASSER MIT HAUSHALTSRFINIGER		○	○		
PRODUZENT SPEZIFISCHER UNTERHALT					○

## ITALIANO - SVIZZERA

### CONSIGLI DI MONTAGGIO

- 1 > STUDIARE BENE LE ISTRUZIONI DI MONTAGGIO.
- 2 > PRENDERE CONOSCENZA DEI PEZZI CHE COSTITUISCONO IL MOBILE.
- 3 > RAGGRUPPARE E CONTROLLARE LA FERRAMENTA.
- 4 > MUNIRSI DEGLI UTENSILI NECESSARI.
- 5 > PREPARARE UNA ZONA DI MONTAGGIO.
- 6 > PROCEDERE AL MONTAGGIO.



**NON FORZARE MAI GLI ASSEMBLAGGI RISTRINGERE LE VITI DOPO UN PERIODO D'USO CONSERVARE QUESTE ISTRUZIONI DI MONTAGGIO, SE UN PEZZO VENISSE A MANCARE SAREBBE IL MIGLIORE MEZZO DI COMUNICAZIONE CON IL RIVENDITORE**

### CONSIGLI PER LA MANUTENZIONE :

- 1 > SPOLVERATE ACCURATAMENTE.
- 2 > USARE UN PANNINO ASCIUTTO.



**- NON UTILIZZARE MAI PRODOTTI ABRASIVI: POLVERE, LANA DI ACCIAIO, SOLVENTI. - NON BAGNARE.**

	CARTA	SUPERFICIE STRATIFICATE	SUPERFICIE LACCATE	LACCATE EGNO VERNICIATO	TESSILE CUIRO
ACQUA CON SAPONE (SAPONE NEUTRO)	○	○	○	○	○
ACQUA CON DETERSIVO SAN MARC		○	○		
MANUTENZIONE SPECIFICA PRODUTTORE					○

## PORTUGUÊS

### CONSELHOS DE MONTAGEM:

- 1 > ESTUDE BEM AS INSTRUÇÕES DE MONTAGEM.
- 2 > REUNA AS PEÇAS QUE CONSTITUEM O SEU MÓVEL.
- 3 > REAGRUPE AS FERRAGENS.
- 4 > EQUIPE-SE COM AS FERRAMENTAS NECESSÁRIAS.
- 5 > PREPARE UMA ÁREA PARA A MONTAGEM.
- 6 > INICIE A MONTAGEM.



**NUNCA FORÇAR OS ENCAIXES.**  
REAPERTAR OS PARAFUSOS APÓS UM TEMPO DE UTILIZAÇÃO.  
GUARDAR AS INSTRUÇÕES DE MONTAGEM.  
CASO FALTE ALGUMA PEÇA, O MAIS ACONSELHÁVEL  
É CONTATAR O REVENDEDOR.

### CONSELHOS PARA A MANUTENÇÃO:

- 1 > ELIMINAR BEM O PÓ.
- 2 > USAR PAÑO SECO.



**- NUNCA UTILIZAR PRODUTOS  
ABRASIVOS: SAPONÁCEOS,  
LÃ DE AÇO, SOLVENTES.  
- NÃO MOLHAR .**

	ACABAMENTO IMITAÇÃO	SUPERFÍCIES ESTRATIFICADAS	SUPERFÍCIES LACADAS	MADEIRA ENVERNIZADA	TEXTEIS PELES
ÁGUA COM SABÃO (SABÃO NEUTRO)	<input type="radio"/>	<input type="radio"/>	<input type="radio"/>	<input type="radio"/>	<input type="radio"/>
ÁGUA COM DETERGENTE		<input type="radio"/>	<input type="radio"/>		
INSTRUÇÕES ESPECÍFICAS DO FABRICANTE					<input type="radio"/>

## ESPAÑOL

### CONSEJOS PARA EL MONTAJE:

- 1 > ESTUDIE ATENTAMENTE EL MANUAL DE MONTAJE.
- 2 > LOCALICE LAS PIEZAS QUE CONSTITUYEN SU MUEBLE.
- 3 > REUNA Y CONTROLE LOS TORNILLOS.
- 4 > EQUIPE-SE DE LAS HERRAMIENTAS NECESARIAS.
- 5 > PREPARE UNA ZONA DE MONTAJE.
- 6 > REALICE EL MONTAJE.



**NO FUERCE NUNCA EN LAS UNIONES. APRIETE LOS  
TORNILLOS DESPUES DE CIERTO TIEMPO DE UTILIZACION  
CONSERVE SU MANUAL DE MONTAJE,  
SI FALTARA UNA PIEZA, SERIA LA MANERA  
MAS FACIL DE COMUNICAR CON LA TIENDA.**

### CONSEJOS PARA EL MANTENIMIENTO:

- 1 > DESPOLVOREAR CULDADOSAMENTE.
- 2 > UTILICE UN PAÑO SECO.



**- NO USE NUNCA PRODUCTOS  
ABRASIVOS TALES COMO:  
POLVO DE LIMPIAR,  
LANA DE ACERO, SOLVENTES.  
- NO MOJAR.**

	PAPEL DE DECORACION	SUPERFICIE ESTRATIFICADAS	SUPERFICIE MAQUEADAS	MADERA BARNIZADA	TEXULL CUERO
AGUA Y JABON (JABON NEUTRO)	<input type="radio"/>	<input type="radio"/>	<input type="radio"/>	<input type="radio"/>	<input type="radio"/>
AGUA COM DETERGENTE		<input type="radio"/>	<input type="radio"/>		
MANTENIMIENTO ESPECIFICO DEL FABRICANTE					<input type="radio"/>

## HRVATSKA

### UPUTE ZA MONTAŽU:

- 1 > PAŽLJIVO PROČITAJTE UPUTE ZA MONTAŽU.
- 2 > PRIPREMITE SVE DIJELOVE NAMJEŠTAJA.
- 3 > PRIKUPITE I PROVJERITE OKOVE ZA MONTAŽU.
- 4 > PRIPREMITE POTREBAN ALAT.
- 5 > PRIPREMITE PROSTOR ZA MONTAŽU.
- 6 > POČNITE MONTIRATI.



**NEMOJTE UPOTREBLJAVATI SILU PRILIKOM SKLAPANJA  
NAKON NEKOG VREMENA PONOVRNO PRITEGNITE VIJKE  
ČUVAJTE UPUTE ZA MONTAŽU  
U SLUČAJU NEDOSTATKA NEKOG DIJELA NAJBOLJE ĆE BITI DA  
DA KONTAKIRATE PRODAJNO MJESTO.**

### UPUTE ZA ODRŽAVANJE :

- 1 > PAŽLJIVO OBRISATI PRAŠINU.
- 2 > KORISTITE SUHU KRPU.



**- ZABRANJENA JE UPOTREBA  
KEMIKALIJA ILI BILO KAKVIH  
POMOĆNIH SREDSTAVA ZA RIBANJE  
JAKIH SREDSTAV ZA ČIŠĆENJE ILI  
ČELIČNE VUNE  
-NE MOKRA.**

	PAPIR	LAMINAT	LAK	DRVO	TEKSTIL/ KOŽA
OTPINA SAPUNA	<input type="radio"/>	<input type="radio"/>	<input type="radio"/>	<input type="radio"/>	<input type="radio"/>
OTPINA DETERDŽENTA		<input type="radio"/>	<input type="radio"/>		
NAMJENSKA SREDSTVA					<input type="radio"/>



## TÜRKÇE

### MONTAJ TALİMATLARI:

- 1 > Montaj tanıtım yazısını dikkatlice okuyunuz.
- 2 > Mobilyanızı oluşturan parçaları iğretleyiniz.
- 3 > Hırdavatla ilgili parçaları bir araya toplayıp; kontrol ediniz.
- 4 > Gereken araç ve gereci tedarik ediniz.
- 5 > (Kendinize) Bir montaj alanı ediniz.
- 6 > Monte etmeye başlayınız.

**MONTAJLARI ZORLAMAYINIZ.**  
BİRKAÇ KULLANIMDAN SONRA VİDALARI SIKIŞTIRINIZ.  
BİR PARÇANIN KAYBOLMASI DURUMUNDA MAĞAZANIZLADAKİ  
KOLAY İLETİŞİME GEÇEBİLMENİZ İÇİN MONTAJ KULLANIM  
TALİMATINIZI SAKLAYINIZ.

### BAKIM TALİMATLARI:

- 1 > TOZUNU DİKKATLİCE ALINIZ.
- 2 > YUMUŞAK BİR BEZİ TEMİZ SU VE AZ MİKTARDA SABUNLA(DETERJAN) NEMLENDİRİNİZ.

- ASLA AŞINDIRICI ÜRÜNLER  
KULLANMAYINIZ : ÇELİK YÜNÜ,  
SOLVENT...  
- BOL SUYLA YIKAMAYINIZ.

	SÜS KAĞIDI	KATMAN YÜZEY	LAKE YÜZEY	ÇİRALI TAHTA	TEKSTİL DERİ
SABUNLU SU (NÖTR SABUN)	○	○	○	○	○
DETERJAN KATILMIŞ SU		○	○		
ÜRETİCİYE ÖZGÜ BAKIM					○

## ENGLISH

### ASSEMBLY ADVICE :

- 1 > CAREFULLY READ THE ASSEMBLY INSTRUCTION.
- 2 > IDENTIFY THE COMPONENTS OF THE FURNITURE.
- 3 > GROUP AND CHECK THE HARDWARE.
- 4 > USE THE REQUIRED TOOLS.
- 5 > CREATE AN ASSEMBLY ZONE.
- 6 > MAKE THE ASSEMBLY.

**NEVER FORCE THE CONNECTIONS.**  
RE-TIGHTEN THE SCREWS AFTER FEW DAYS.  
PLEASE RETAIN THE AI LEAFLET FOR FUTURE REFERENCE,  
THE AI CONTAINS INFORMATION WHEN CLAIMING  
FOR MISSING PARTS.

### CLEANING ADVICE:

- 1 > CAREFULLY REMOVE THE DUST.
- 2 > USE A SOFT, CLEAN DAMP CLOTH WITH SOAPY WATER.

**NEVER USE ABRASIVE PRODUCTS  
OR SOLVENTS.**  
DO NOT APPLY EXCESSIVE PRESSURE  
WHEN USING THE DAMP CLOTH.

	PAPER DECOR	LAMINATED SURFACES	LACQUERED SURFACE	VARNISHED WOOD	LEATHER TEXTILE
SOAPY WATER (NEUTRAL SOAP)	○	○	○	○	○
WATER WITH DETERGENT		○	○		
SPECIFIC SUPPLIER CLEANING					○

**PENSEZ AU TRI !**  
ENSEMBLE RÉDUISONS  
L'IMPACT ENVIRONNEMENTAL  
DES EMBALLAGES

ÉLÉMENT(S)  
PLASTIQUE(S)  
À JETER

ÉLÉMENT(S)  
MÉTAL(S)  
CARTON(S) PAPIER(S)  
À RECYCLER



CONSIGNE POUVANT VARIER LOCALEMENT > WWW.CONSIGNESDETRI.FR



FR

Donnez ou recyclez  
vos meubles.



Association

ou



Magasin

ou



Déchèterie

<https://quefairedemesdechets.fr>