

INSTRUKCJA MONTAŻU

ASSEMBLING
INSTRUCTIONS
13.04.2022 rev 0

LEON 3 PLACE convertible



30 min



x1



x1



x2

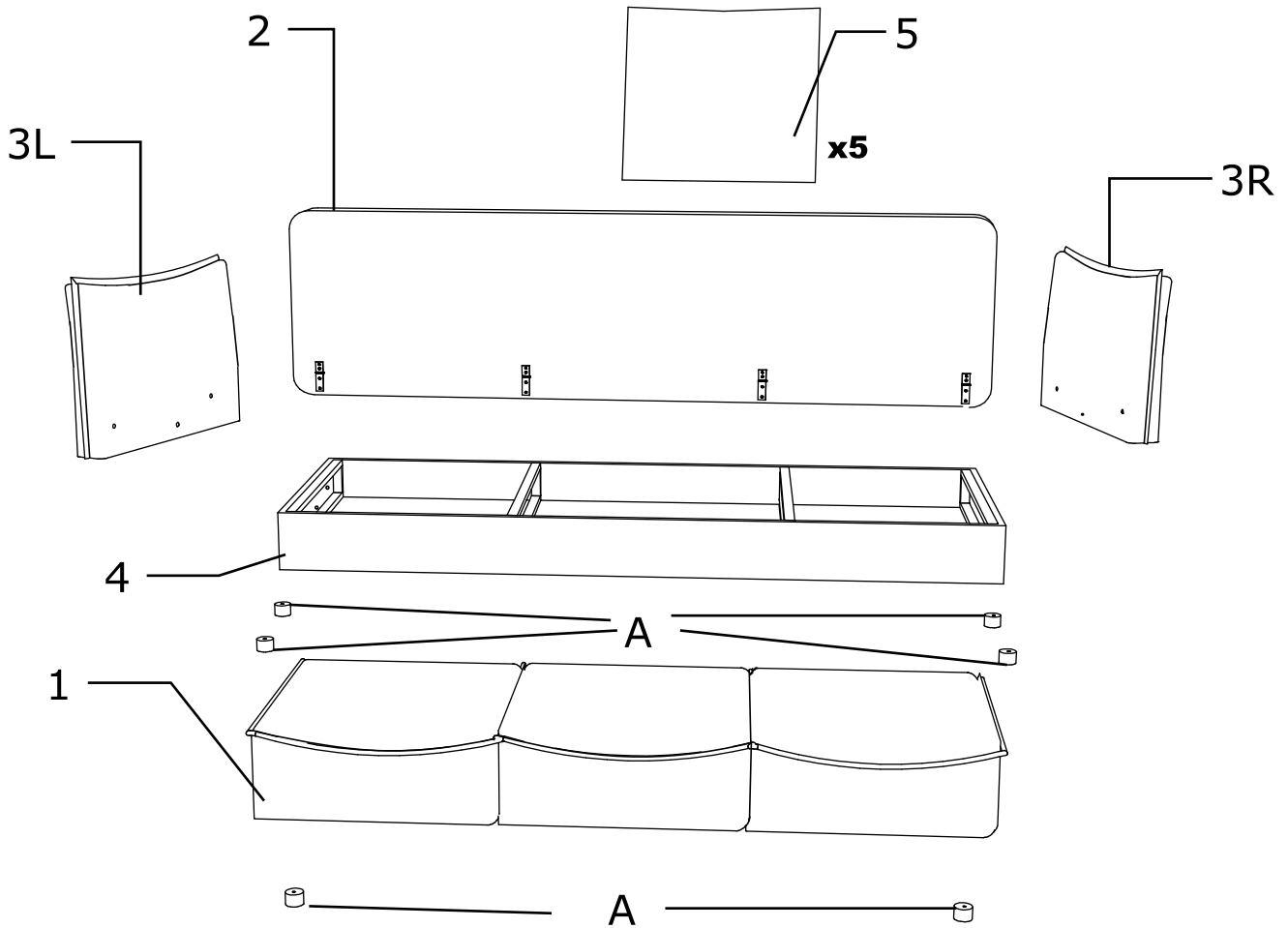
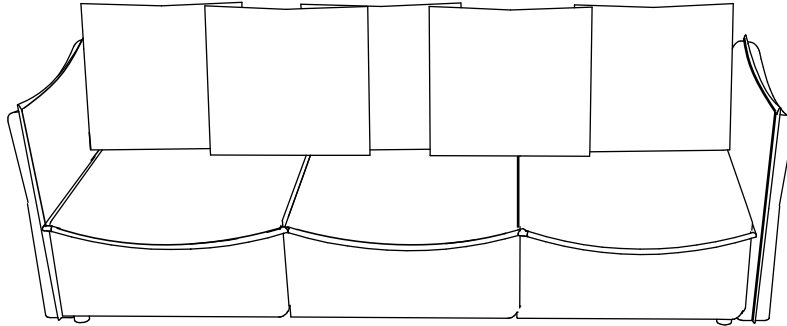

A x6



B x6



C x6

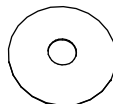

D x6



E x6



C

1

4

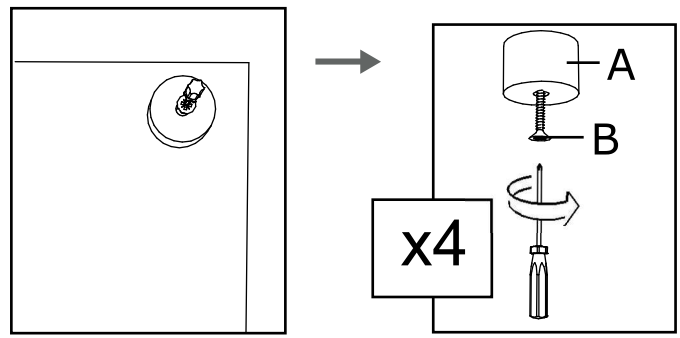
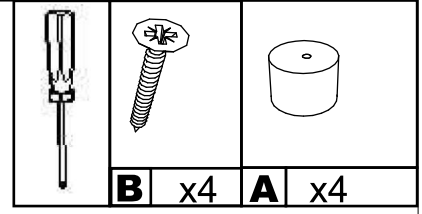
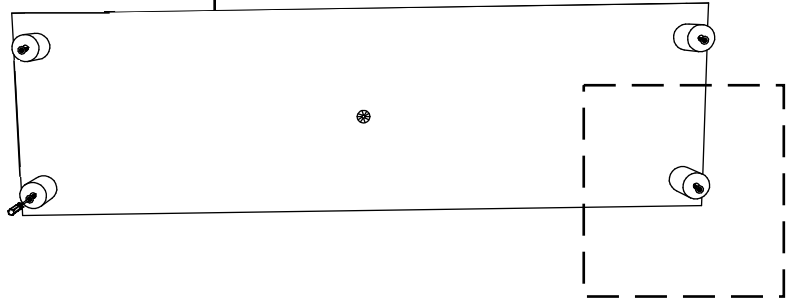

1

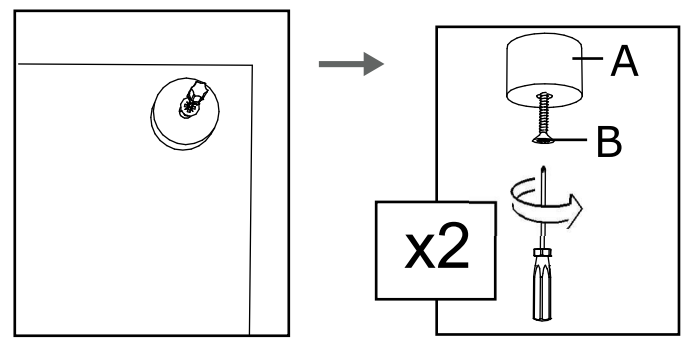
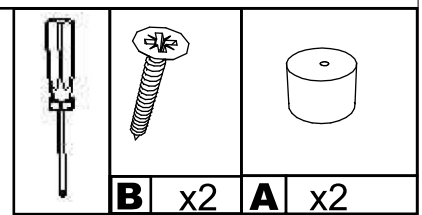
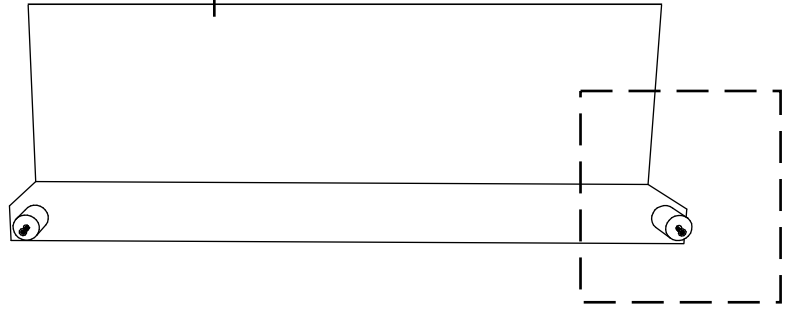

2

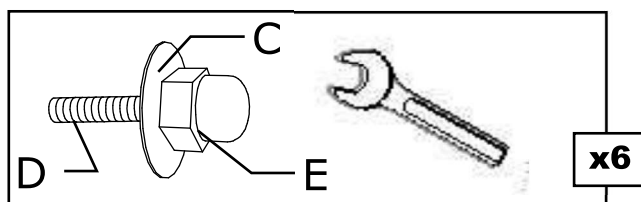
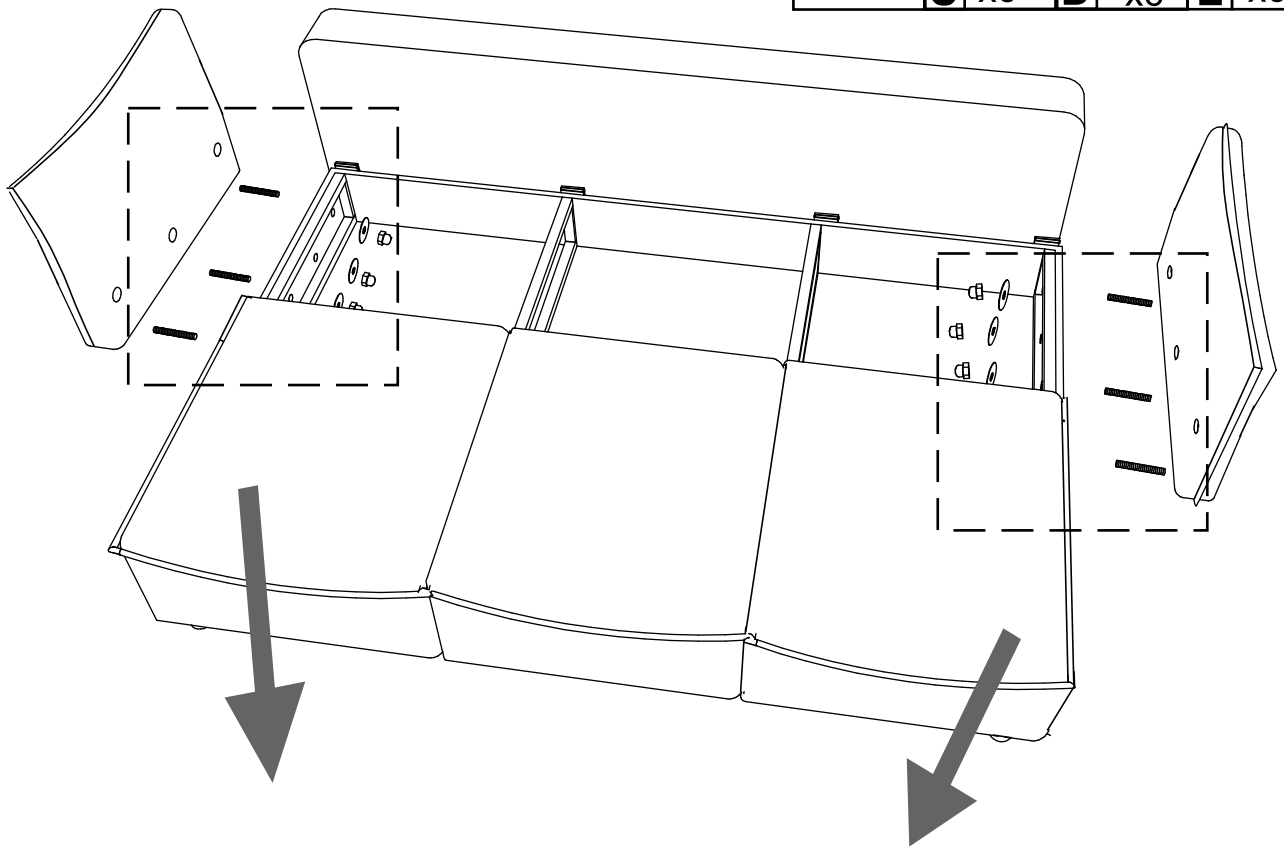
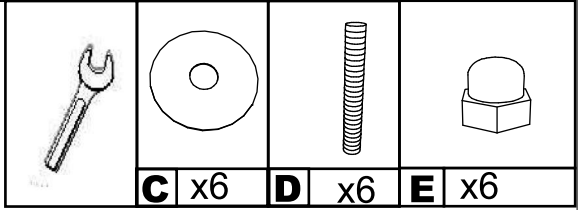
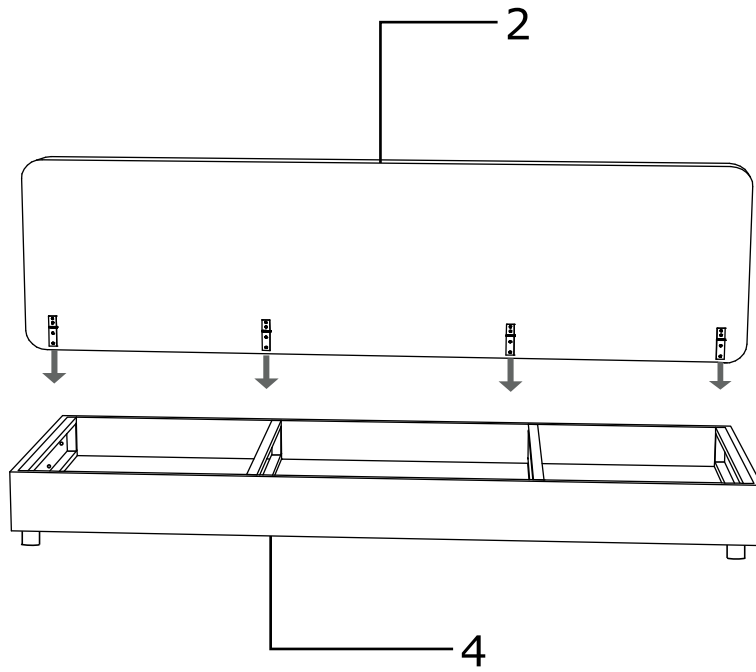

3

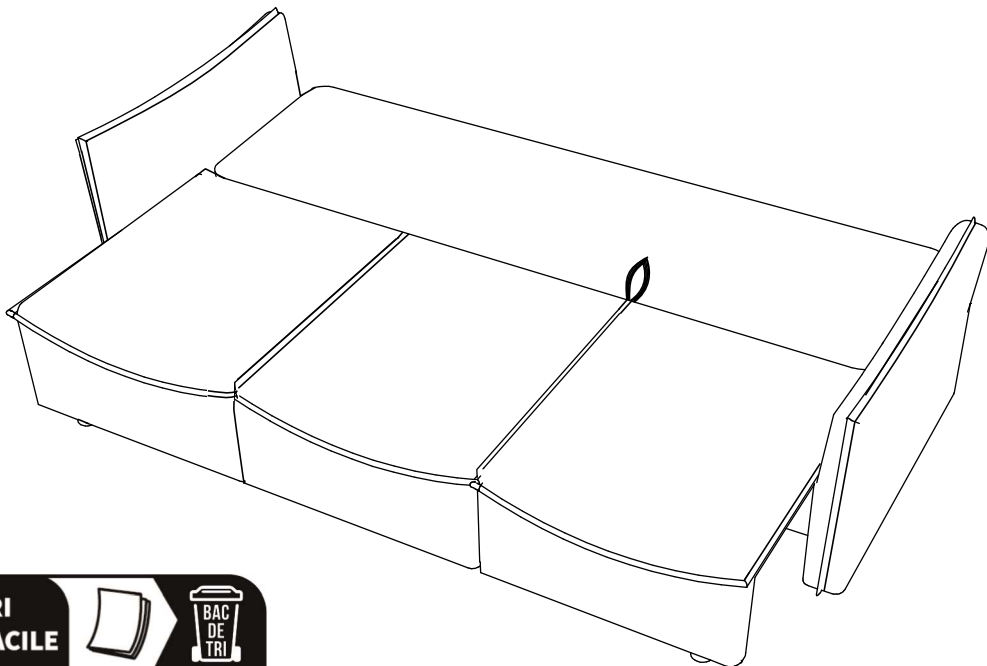
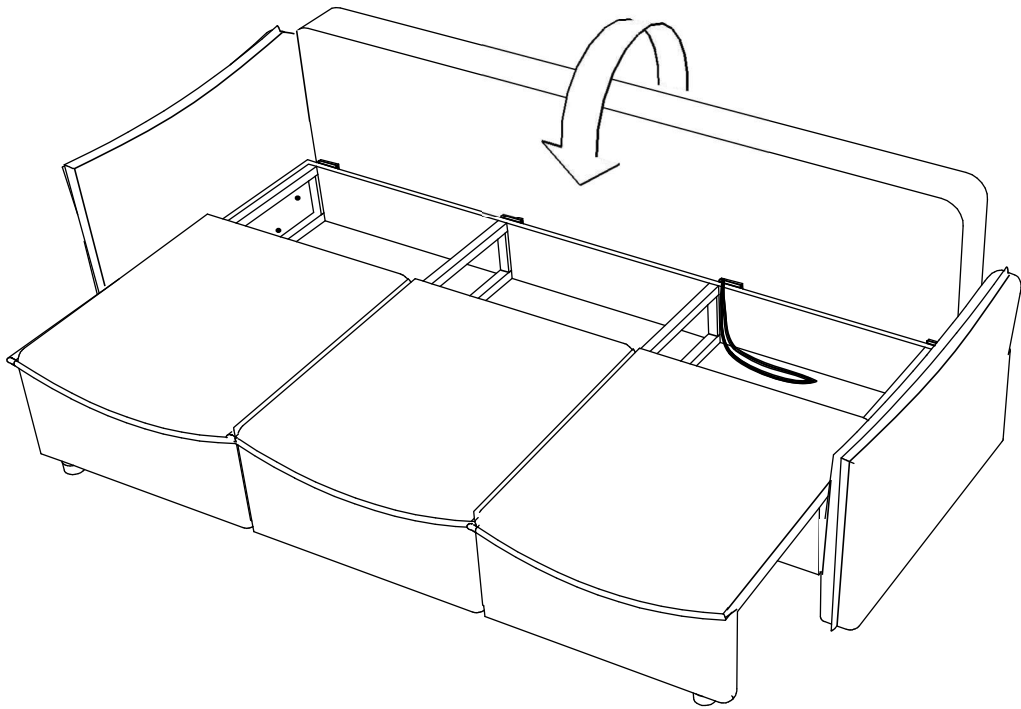
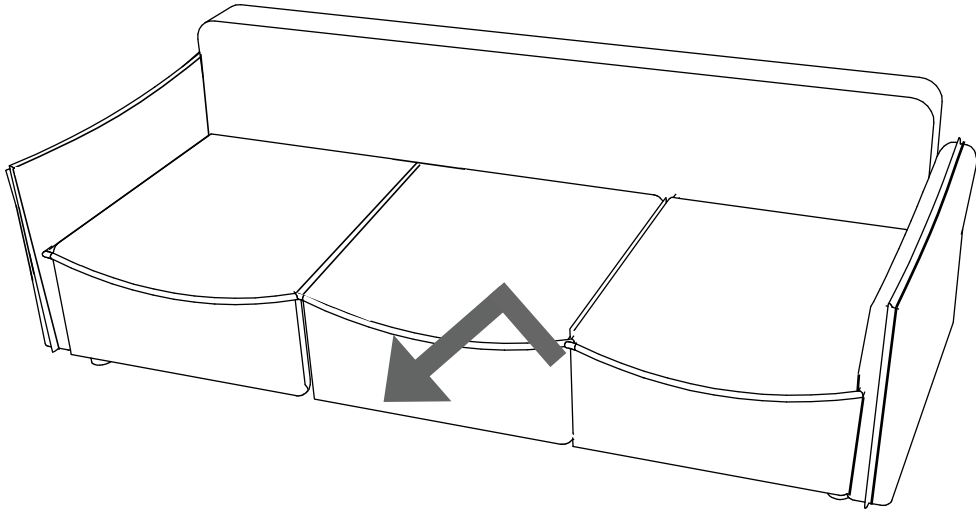

LE TRI
+ FACILE



BAC
DE
TRI